

Kaled Machal

**Plug in and touch**

Thesis

**CENTRAL OSTROBOTHNIA UNIVERSITY OF APPLIED SCIENCES**

**Ylivieska Unit**

**Industrial Management**

**April 2010**

**ABSTRACT**

CENTRAL OSTROBOTHNIA UNIVERSITY OF APPLIED SCIENCES	Date <b>27.4.2010</b>	Author Kaled Machal
Degree programme	<b>Industrial Management</b>	
Name of thesis	<b>Plug in and touch</b>	
Instructor	Pages <b>58</b>	Seppo Jokelainen
Supervisor	<b>Seppo Jokelainen Kaija Arhio</b>	
<p>Invention is a challenging task, special when there is a similar product in the market. There are numerous alike products in the market made for the same purpose but owned and invented from different manufactures. These comparable products have same functions but different shapes, looks, dimensions, materials, etc.</p> <p>The overflow of new touch screen devices in the market, which keeps increasing all the time, requires the consumers to buy new touch screen pen. Most of devices come with one touch screen or none. There are quite many touch screen pens already in the market, known usually as stylus pen. They are made from the virgin plastics raw material.</p> <p>Taking a close look to the stylus pens prices in the market, it is convenient to produce new type of touch screen pens. The recycled plastics and biodegradable plastics will be used as raw material to fabricate the new product.</p> <p>The designing will be performed using the Solid Edge academic software. The design will include the product shape and the products mold.</p> <p>The product maybe sold to an existing pen maker company or other companies which produce a touch screen devices.</p>		
<p><b>KEY WORDS:</b> New invention, Product design, Price, Environment.</p>		

## **ACKNOWLEDGE**

It was a great pleasure to write thesis in Central Ostrobothnia University of Applied sciences, Ylivieska unit.

Special thanks to my supervisor Sir, Seppo Jokelainen for all his great help and orientations. Special thanks to Sir, Ossi Paivalainen, Madam, Kaija Arhio, without forgetting the Sweet lady the Study secretary Eva Niskanen for all her efforts in helping me to become an official student in Central Ostrobothnia University of Applied sciences.

I am also grateful for the laboratory crew.

## LIST OF FIGURES

Figure 1: Linear and branched thermoplastics molecules

Figure 2: Cross-linked thermoset plastics molecule.

Figure 3: Recycling plastics and energy rate per country 2008

Figure 4: World plastics production between years 1950- 2008

FIGURE 5: Injection molding schematic machine

FIGURE 6 & 7: Injection molding part production cycle

FIGURE 8: CNC machine Control Unit

FIGURE 9: MCUs have screen monitor

FIGURE 10: Test design for touch screen pen

FIGURE 11: New touch screen product design

FIGURE 12: The sketch of top and bottom diameters of the product sample A.

FIGURE 13: The 3-D shape of the product sample A cylinder

FIGURE 14: The cut out of the material from the cone head to enable the part to be ejected with ejector pins.

FIGURE 15: Draft design of the sample A

FIGURE 16: Draft design of the sample B

FIGURE 17: Cavity plate product sample A

FIGURE 18: Core plate product sample A

FIGURE 19: Isometric drawing of the cavity plate sample A

FIGURE 20: The drawing of the half cut out of the inner nest or cavity of the sample A

FIGURE 21: The draft design for the core plate concerning the sample A

FIGURE 22: The cavity plate concerning the sample B

FIGURE 23: The design draft of cut out of the half inner nest concerning sample B

FIGURE 24: The draft design of runners for both sample and sample B

FIGURE 25: The core plate sample B out look

FIGURE 26: The draft design of the core plate concerning the sample B

FIGURE 27: The assembly regarding the sample A, core plate and cavity plate

FIGURE 28: The assembly regarding the sample B, core plate and cavity plate

FIGURE 29: The mould for the product sample A and sample B

FIGURE 30: The mold explodetion

FIGURE 31: The total projected area

FIGURE 32: Clamping pressures for different cavity geometries

FIGURE 33: Polypropylene sample A mass = 0.002 Kg

## List of TABLES

TABLE 1: Plastics recycling codes

TABLE 2: Some G-codes list for CNC machine.

TABLE 3: Some M-codes list for CNC machine.

TABLE 4 and TABLE 5: Available colors for the touch screen pen sample A and sample B.

TABLE 6: The viscosity factor for some polymers

Table 7: SWOT Analysis (Strength, weakness, Opportunity, Threat)

## VOCABULARY

Resins: Plastic raw material

Pellets: Same as resin, small part of plastic raw material

Plasticator: The area in the injection moulding machine where the plastics is melted

Sprue : The channel in the core plate through which the plastics travel to enter the runners

Coolant: The part which holds the machining tool

Masterbatches: Plastic formulation consisting of a mixture of plastic and one or more additives

Parts core: The body which enables the shape of the inner part.

Runners: The channels through which the plastics travel to the cavities.

Isometric Drawing: method of graphic representation of three-dimensional objects, it has top, front and side view of the drawing body.

Explodetion : the mould parts detached at a certain distance in order to get a good view of all parts comprised in the mould.

## TABLE OF CONTENTS

1.	INTRODUCTION.....	1
2.	HISTORY .....	2
3.	PRICES AND MARKET GROWTH OF TOUCH SCREEN DEVICES.....	3
3.1	Prices .....	3
3.2	Market growth of touch screen devices.....	3
4.	PRODUCT AND PATENT.....	5
4.1	Defining the product .....	5
4.2	PATENT .....	5
5.	MATERIAL SELECTION.....	7
5.1	Polymers .....	7
5.2	Additives.....	10
5.2.1	Anti-aging additives .....	10
5.2.2	Colorants and Blowing agents.....	10
5.2.3	Lubricants .....	10
5.2.4	Plasticizers .....	11
5.2.5	Fillers.....	11
5.3	Applications of thermoplastics.....	11
5.4	Plastics raw material suppliers .....	12
5.5	Chemical properties .....	12
5.6	Mechanical properties .....	12
5.7	Physical properties.....	12
5.8	RECYCLED PLASTICS .....	13
5.9	SORTING PLASTICS .....	13



6.	BIO-DEGRADABLE PLASTICS .....	17
6.1	Bio-degradable.....	17
6.2	Bio-polymers .....	17
6.3	Advantages .....	17
6.4	Application of Bio-polymers (bio-thermoplastics) .....	18
6.5	Ethical issues .....	18
7.	MANUFACTURING THE PRODUCT.....	19
7.1	Injection molding background.....	19
7.1.1	Injection molding machines (IMM) .....	19
7.1.2	Injection molding machines manufacturers.....	22
7.2	Characteristics of injection molding machine .....	22
8.	DESIGNING THE PRODUCT .....	23
8.1	Solid Edge.....	23
8.2	Master cam .....	24
8.3	G-codes and M-codes.....	24
8.4	M-codes .....	25
8.5	CNC machine.....	25
8.5.1	Advantages.....	25
8.5.2	Disadvantages.....	26
8.5.3	Elements of a CNC machine .....	26
9.	DESIGN PROCESSING .....	28
9.1	Product design .....	28
9.2	Measurements .....	29
9.2.1	Sample A .....	29

9.2.2	Draft design sample A .....	32
9.2.3	Draft design sample B .....	32
9.3	Samples A &B colors .....	33
9.4	Raw material .....	35
9.5	Bio-degradable plastics.....	36
10.	MOULD DESIGN.....	37
10.1	Cavity plate .....	37
10.2	Core plate .....	38
11.	Draft design .....	39
11.1	Draft cavity plate design sample A.....	39
11.2	Draft core plate design sample A.....	40
11.3	Draft cavity plate design sample B.....	41
11.4	Core plate design draft for sample B.....	44
11.5	G-codes & M-codes example (core plate sample A).....	45
11.6	Assembly .....	46
11.6.1	Assembly sample A.....	46
11.6.2	Assembly sample B.....	46
11.6.3	Mould View.....	47
11.7	Clamping force.....	48
11.8	PHYSICAL PROPERTIES OF THE SAMPLE A .....	51
11.9	COST OF RECYCLED PLASTICS .....	51
12.	PRODUCT EVALUATION .....	54
12.1	SWOT ANALYSIS.....	54
12.2	MARKETING .....	54
12.3	RECOMMENDATION .....	55

13. REFERENCES .....	56
----------------------	----

## 1. INTRODUCTION

Nowadays most of people use touch screen devices such as PDA, mobile phones, mp3, etc. The consumption of these devices is increasing all the time. The genuine touch screen pen is expensive, and once the pen is lost, the consumer has to pay a considerable amount of money to get a new genuine one. There is already such product in the market made from by different manufacturers. But the price is still high although is much cheaper than the original pens.

The original touch screen and the existing cheaper pens are usually made from a virgin plastics raw material. It will be wise to produce a new cheaper type of touch screen pen made from different materials.

The product has to be novel avoiding the copy rights of the existing ones in nowadays market. The procedure structure will involve the history of touch screen and a close look to the market growth of the touch screen devices. A special nature friendly material will be selected, then designing the product and its mold using suitable designing program.

The new product will encompass the same function as the original pen. It will have a unique design. The product will have a good position in the market. Many consumers will purchase the new product. The product can be sold to a particular company.

## 2. HISTORY

The touch screen technology was invented in year 1971 by Sam Hurst, Doctor at the University of Kentucky (UK). They called it touch sensor with a brand name Elograph. It was dim non-transparent compared to nowadays touch screens; doctor Sam Hurst patented his invention in 1972 as Elographics under The University of Kentucky Research Foundation. In 1977 the Siemens Corporation offered a financial support to the Elographics to produce the first curved glass touch sensor which is called afterward a touch screen. In the same year 1977, Elographics developed and patented five-wire resistive technology, which is the most popular touch screen technology in use today.

On February 24, 1994, the company officially changed its name from Elographics to Elo Touch Systems. Today Elo Touch Systems offers a major selection of touch screen technologies and LCD touch monitors and carefully designs each product for the challenging requirements of various applications, such as industrial, medical, transportation, office, automation, gaming, etc. (Elo Touch Systems 2010.)

Many universities and manufacturers were interested in producing touch screen devices. Such manufacturers are: Nokia, Hp, Lenovo, Motorola, Apple, etc. For the interest is the possibility to reduce the size and the weight of the electronic devices. On the other hand the device with a touch panel will have an attractive look, allowing users to navigate a device system by touching icons or links on the screen. Users of the touch screen have complain about in common consisting the fingerprint smudges. They frequently must clean their screens to remove the oily prints that shade the surface. Therefore many manufacturers invented a pen touch screen or so called stylus pen. It allows to keep the surface clean and reducing the risk of electric shock, giving the user extreme accuracy and control over the device. (Market research: Gigantti, Verkkokauppa, Tarjoustalo 2010.)

### **3. PRICES AND MARKET GROWTH OF TOUCH SCREEN DEVICES**

#### **3.1 Prices**

When a customer purchases a touch screen device, usually the stylus pen comes with the package. If the pen gets lost, the customer has to buy a new genuine one which is expensive. Non-genuine stylus pen prices vary from 1 € to 10€ per item in Finland and the UK. Different manufacturers have different products with a special design, using particular material and processing methods therefore different prices. (Market research: Tarjoustalo, Gigantti, Verkkocauppa 2010.)

#### **3.2 Market growth of touch screen devices**

Iphone and iPods are of the most famous touch screen devices. Apple company provides its consumers with latest technology, offering a various applications in a small electronic device.

Nancy Paxton the Apple Investor Relations department has stated that: “We don't report iPod sales by model, but in terms of iPhones, unit sales were as follows:

Fiscal 2007 1.389 million

Fiscal 2008 11.627 million

Fiscal 2009 20.731 million

We also sold 8.737 million iPhones in the first quarter of Fiscal 2010.

Additionally, at our iPad introduction event on January 27, we mentioned that we had sold over 75 million cumulative iPhones and iPod touches. “ (The information has been sent by e-mail from Nancy Paxton the Apple Investor Relations department.)

The popularity of touch screens on smart phones has increased extremely since Apple introduced its Iphone. More than half of all smart phones companies are producing new devices with a touch panel. Nokia the world leading vendor of cell phones is entering the world of touching icons by launching its first touch screen smart phone 7700 and in October 2008, (Nokia 5800 Xpress music), without forgetting the well known Nokia N97 fifth generation mobile phone. (Nokia 2010.)

Samsung as well has launched various smart phones with a touch panel; it has large number of consumers all over the world, offering a unique technology which satisfies their costumers, with growing sales every year. (Samsung 2010.)

In general the touch screen devices market is growing extremely fast. This will open new market for the stylus pen in order to tap the screen for convenience and better control.

## **4. PRODUCT AND PATENT**

### **4.1 Defining the product**

The product will be a stylus pen made named” plug in and touch” made out of appropriate polymer or polymer mixed with other material, for example wood. It will be suitable for all touch screen devices, such as smart phones, PDA, music players, computers etc. There are three options of selecting the raw material for the product as follow:

Virgin or normal raw material plastics

Recycled plastics

Bio-degradable plastics (bio-plastics)

However, as usually when inventing a new product there will be obstacles to overcome along the process. Studying the similar product, finding new ideas, with new design will offer something new to the existing product. This will bring us to think about the similar patented product in market. (Name: plug in and touch was invented with the help of the supervisor: Mr, Seppo Jokelainen.)

### **4.2 PATENT**

A patent is a license contracted to an inventor, which gives her or him the right to stop anyone else from making, using or selling his or her invention without his or her permission.

According to the National Board of Patents and Registration of Finland (NBPR), for an invention to be patentable it has to be novel. Exclusive right is not accorded to old, previously known technology. The inventor shall not make his or her invention available to the public before filing for a patent. The filing date is the crucial limit. Anything that has become known before it anywhere in the world may form an obstacle to patenting the invention.

Besides being novel, the invention must also involve an inventive step. The Patents act expresses the same thing by saying that the invention has to differ essentially from those that have become known previously. The other precondition for



patentability is industrial applicability. By this legislators have expressed their willingness to restrict the group of patentable inventions to technical solutions. Industrial applicability shall, however, be understood in a broad sense. Besides conventional industry, it includes the methods and devices needed in commerce, building industry, farming, forestry, gardening, fishing, handicrafts etc. (National Board of Patents and Registration of Finland (NBPR).).

As conclusion the existing stylus pen will be developed, with new look, new design, made out of special material, offering a good control over any touch screen devices.

## 5. MATERIAL SELECTION

### 5.1 Polymers

“Poly” means many, “mer” means part, it refers to many parts joint together to form one large molecule. Polymers consist of extremely large chain-like molecules that are in turn made up of numerous smaller, repeating units called monomers. Chains of polymers can be seen like a paper clips linked together in long line.

Polymers can be natural or synthetic. The natural polymers covered include proteins polysaccharides (Cellulose, starch), nucleic acids (DNA, RNA) and rubber. Synthetic polymers are produced commercially on a very large scale. They have a wide range of properties and uses. All Plastics are synthetic polymers. Synthetic polymers can be made from monomers by two basic polymerization processes:

Addition polymerization: monomers with double-bonds open up to form continuous chain.

Example:

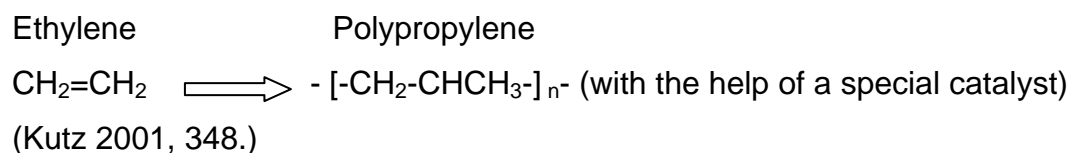

Step growth polymerization or condensation Polymerization: elimination of smaller molecule when functional groups react and the water is formed, the water is removed then, other monomer will react with other functional group (-OH), the well know example is:

Example:

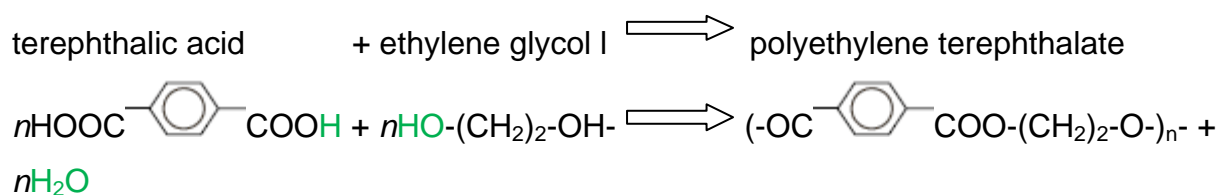

(Kutz 2001, 352.)

Most of synthetic polymers are classified generally in three main categories: thermoplastics, thermosets, and elastomers. However, usually plastics are classified either thermoplastics or thermosets.

A thermoplastic material is a polymer with a high molecular weight that is not cross-linked. A thermoplastic material can exist in a linear or branched structure. Upon heating a thermoplastic a highly viscous liquid is formed that can be reshaped using plastics processing equipment. As candle wax, thermoplastics can be heated and cooled, and consequently softened and hardened, repeatedly. For this reason, thermoplastics can be remolded and reused almost indefinitely.

On the other hand, thermoset plastics consist of cross-link chain molecules. When thermosetting plastics are cross-link, the molecules build an everlasting three-dimensional network. Once cured, thermosetting plastics cannot be re-melted, in the same way as egg once boiled cannot return to its initial state or reused again.

Thermoplastics and thermosets plastics are terms that describe how a polymer behaves when subjected to heat and cooled. (Kutz 2001, 347.)

The dissimilar molecular structures of thermoplastics and thermosets plastics permit manufacturers to modify the properties of commercial plastics for definite applications. Since thermoplastic materials consist of linear or branched molecules, the properties of thermoplastics are principally affected by molecular weight. For example, increasing the molecular weight of a thermoplastic material increases its tensile strength, impact strength, and fatigue strength giving the material the ability to resist constant stress. On the contrary, thermosetting plastics consist of a single molecular network; molecular weight does not significantly influence the properties of these plastics. As a substitute, many properties of thermoplastics are determined by adding together diverse types and quantity of fillers and reinforcements, like carbon fibers. (Kutz 2001, 346.)

The thermoplastics have usually linear or branched molecules as shown in the figure 1 below:

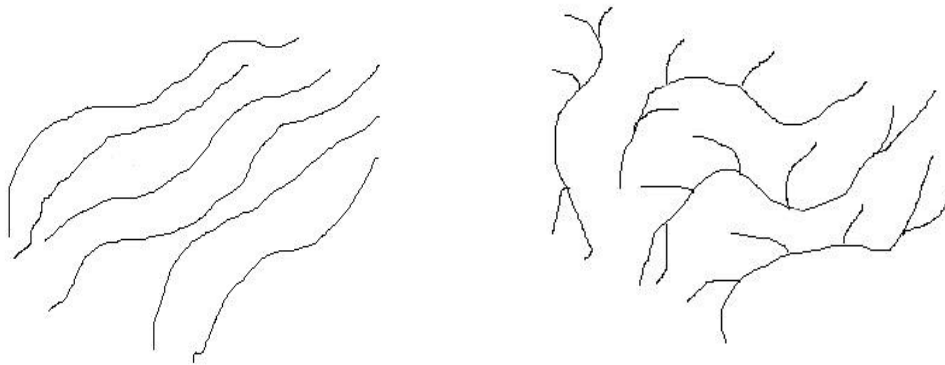

Linear molecules: Thermoplastics

[Kaled Machal thesis 2010: Keski-pohjanmaan AMK](#)

Branched molecules: Thermoplastics

[Kaled Machal thesis 2010: Keski-pohjanmaan AMK](#)

FIGURE 1. Linear and branched thermoplastics molecules

Thermosets are likely to have a different structure than Thermoplastics; the molecules are cross-linked together as it shows in the figure 2:

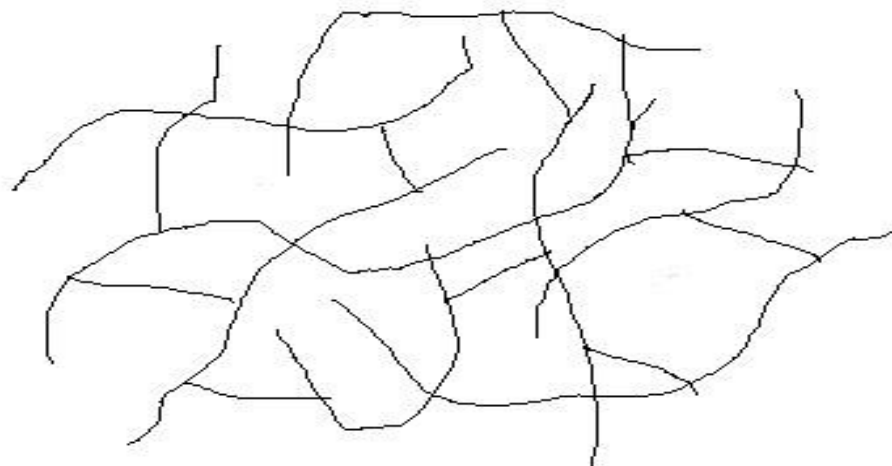

Cross-linked molecules: Thermosets

[Kaled Machal thesis 2010: Keski-pohjanmaan AMK](#)

FIGURE 2. Cross-linked thermoset plastics molecule

The product in question will be made essentially from a thermoplastics material. Thermoplastics are most commonly used for many different applications due to their special properties. Many thermoplastics or polymers in general are almost worthless, unless they are converted into highly practical products by combining them with a variety of additives, stabilizers etc., by the compounding or blending process. Then they can be used to make a desired product. The exact formulation or mixture will depend upon the specific application requirement. The different additives offer different physical properties which are used to improve the performance of the

thermoplastics materials. Additives are widely used for thermoplastics, thermo sets and elastomers. Some of the compounding materials are stabilizers, plasticizers, fillers, colorants or pigments, lubricants and accelerators.(Happer 1999, 79-83.)

## **5.2 Additives**

### **5.2.1 Anti-aging additives**

Thermoplastics' aging includes attack by ozone, radical oxygen, and UV degradation. Aging often results in modification of the polymer structure chain. Anti-aging additives are used to prevent these changes.

Antioxidants are added to the polymer to prevent the free-radical reactions that occur during oxidation. Antioxidants include compounds such as phenols and amines. Peroxide decomposers are also added to get better aging properties of thermoplastics or retard it as much as possible.

The absorption of ultraviolet light by a polymer leads to the production of free radicals. These radicals react with oxygen resulting in photodegradation. (Happer 1999, 79-83.)

### **5.2.2 Colorants and Blowing agents**

Colorants are added to give a suitable color for the polymeric material. For a particular desired color, the type of polymer will influence the assortment of the colorants. Blowing agents are added to the polymer to produce a foam or cellular structure. Sometimes they can be chemical blowing agents which decompose at definite temperatures and release a gas or they can be low-boiling liquids which become volatile at the processing temperatures, in order to help the melted polymer to flow easily. (Happer 1999, 79-83.)

### **5.2.3 Lubricants**

Lubricants are added to thermoplastics to assist in processing a high viscosity polymer due to the high molecular weight. Adding lubricants will decrease the melt viscosity to reduce machine wear and energy expenditure. Their presence at the

interface between the polymer and metal walls acts to facilitate the processing of the material. They have low compatibility with the polymer and may contain polar groups so that they have an attraction to metal. It prevents the plastics from sticking to the mold. Examples of these lubricants include stearic acid or other carboxylic acids, soap, waxes, paraffin oils, and certain alcohols and ketones. (Happer 1999, 79-83.)

#### **5.2.4 Plasticizers**

They are added to soften thermoplastics by separating the polymer chains allowing them to be more flexible. As a result, the plasticized polymer is softer with better extensibility. Plasticizers' major role consist in reducing the melt viscosity (to ease the flow of the melted polymer), the plasticizers are selected carefully so they are compatible with the polymer. (Happer 1999, 79-83.)

#### **5.2.5 Fillers**

They are usually inorganic materials, which can be classified according to their effect on the mechanical properties of the resulting combination with the thermoplastics. They are added mainly to reduce the cost and improve some mechanical properties of the final compound, such as modulus or tensile strength. Fillers are generally added to thermosetting plastics to increase their elasticity and crack resistance. Fillers improve thermal stability, strength, non-combustibility, water resistance, electrical insulation properties and external appearance. They may increase the density of the compound allowing lower shrinkage by increasing the hardness. Some examples of fillers are: china clay (kaolin), talc, calcium carbonate, wood flour, Mica, Cotton, Carbon black, Graphite, Barium, Sulphate etc. (Happer 1999, 79-83.)

### **5.3 Applications of thermoplastics**

Thermoplastics are the materials that have the property of plasticity and can be molded into any desired shape and dimensions under heat and pressure.

Thermoplastics can be produced in large number of colors and can be used for decorative purpose.

Thermoplastics can be used to produce complicated shapes and accurate dimensions very cheaply by molding process.

Thermoplastics are used in automobile parts, telephones, electrical instruments, optical instruments, household appliances etc.

Thermoplastics with high wear resistance properties can be used for making gears.

Aerospace engineering

Medical instruments

Computer and electronics

#### **5.4 Plastics raw material suppliers**

Generally when a company launches a new plastics product, the plastics raw material supplier will offer a suitable material. Such suppliers in Finland are: Borealis OY in Porvoo, Premix OY in Rajamäki. Ekiplast OY in Hämeenlinna and Lieksa, Netplast OY in Tampere.

Depending on the cost of the raw material some companies in Finland may purchase a raw material from abroad. Usually it is convenient to deal with a domestic supplier in order to ensure the quality. It will help to build a strong trust and work side by side to improve the goods quality. It has been proven in Finland that a consumer is more likely to buy domestic goods rather than foreigner ones.

#### **5.5 Chemical properties**

The stylus pen will be used in summer and winter, in temperatures between -30 Celsius to 50 Celsius. The product will have water resistance property, non-soluble in most of liquids, (mouth spit) and non toxic. Therefore it will have a chemical resistance to acids, alcohols, gases, oils, rust, UVI, halogens etc. In other words, it has a good chemical stability.

#### **5.6 Mechanical properties**

The material should have a high tensile strength, stable dimension, smooth surface, high impact strength, good shock resistance, and no sharp edges for safety uses for any kind of users no matter is their ages.

#### **5.7 Physical properties**

Very low water absorption

Ultra violet resistance to prevent the product from aging effect

Self-extinguishing

Density greater than one

## **5.8 RECYCLED PLASTICS**

The most known recycled plastics families are thermoplastics. These materials melt and flow when they are heated and solidify as they are cooled. If they are heated at high temperature, they melt and recapture the ability to flow. These properties make them able to be reused or recycled.

Starting from 1992 Mazda the car manufacturer has recycled bumpers scrap which is made of polypropylene. The quality of the bumpers produced from a recycled polypropylene is as fine as those made using original material alone. (Mazda 2010.)

Many manufacturers are worried about the quality of their goods made using the recycled material which they believe might damage their machinery. Some reinforced thermoplastics which have a glass fiber, their quality does decline once reused again, this material properties tends to turn out to be damaged when reprocessed. The mechanical properties of the reinforced plastic, such as strength, depend on the length of the glass fibers used. Consequently, the act of reprocessing reduces this remaining length.

Another obstacle facing the recycling process is the contaminants such as paint, coatings, labels, wood, dust, printing inks, glue, or metals. Metals are a major problem in reprocessing as they can scratch the internal body of the processing machines. Protection from metal damage usually is solved by magnets fixed in the feed hoppers.







## **5.9 SORTING PLASTICS**

All plastics products are labeled with a logo number which shows the family of the raw material used to produce such item. In general the logos numbers are from 1 to 7, the TABLE 1 contains some most used know plastics and their applications in our daily life.



TABLE 1. Plastics recycling codes



Code	Name	Common Use	Recycle Rate	Recommendation
	<b>PET</b> Polyethylene Terephthalate	Plastic bottles (soft drink, single-use water bottles, sport drinks), food jars, cosmetic containers.	23%	Be careful with products labeled No. 1. Designed for single use only. Extended use increases risk of leaching and bacterial growth.
	<b>HDPE</b> High density polyethylene	Grocery Bags, detergent bottles, milk and juice jugs.	27%	Appears to be Safe
	<b>PVC</b> Polyvinyl chloride	Garden hose, cable sheathing, window frames, blister packs, blood bags, meat wrap.	< 1%	Avoid Nicknamed the Poison Plastic, contains many dangerous toxins.
	<b>LDPE</b> Low density Polyethylene	Heavy duty bags, drycleaning bags, bread bags, squeezable bottles, plastic food wrap.	< 1%	Appears to be Safe
	<b>PP</b> Polypropylene	Medicine bottles, cereal liners, packing tape, straws, potato chip bags.	3 %	Appears to be Safe
	<b>PS</b> Polystyrene	CD and video cases, plastic cutlery, foam packaging, egg cartons.	< 1%	Avoid May leach styrene, a possible human carcinogen. May be a hormone disruptor.
	<b>Other</b> <b>PC</b> Polycarbonate	Baby bottles, water cooler bottles, car parts	< 1%	Caution Concern with leaching of Bisphenol A which appears to cause chromosomal damage.

## Useful Tips:

- Store food and water in glass or stainless steel containers whenever possible
- Minimize or eliminate exposure to plastics with code 1, 3, 6, or 7
- Do not use products (especially Baby Bottles) identified with No. 7

[www.PlasticFreeBottles.com](http://www.PlasticFreeBottles.com)

Your source for alternatives to plastic bottles

The labeled numbers in plastics products help recycling companies to group all products to the same plastics families. Therefore each group is processed further, either to produce new recycled raw material or used as a source of energy (figure 3).

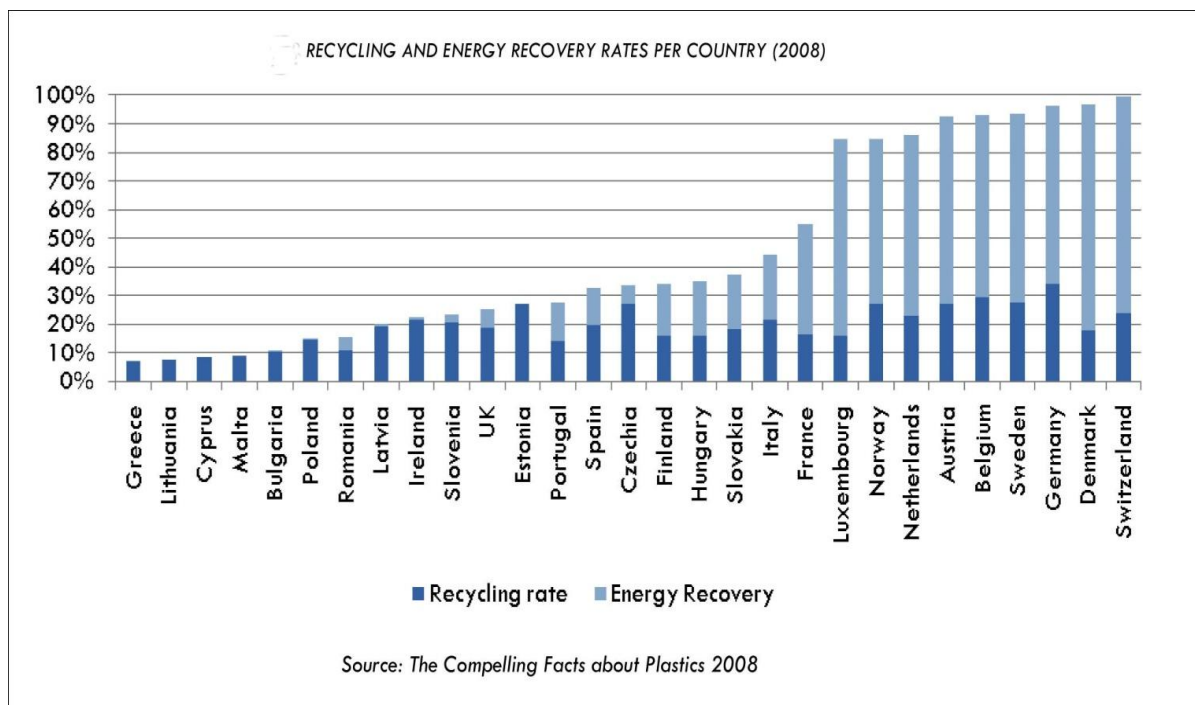

FIGURE3. Recycling plastics and energy rate per country 2008

The recycled plastics have wide applications: Walkways, jetties, pontoons, bridges, fences and signs, damp proof membrane, drainage pipes, ducting and flooring, textile, etc.

Recycled plastics are not used for food contact and medical applications due to the contamination issues. According to EUROPEAN PLASTICS RECYCLERS (EUPR) ASSOCIATION, The European plastics waste generation nearly reached 25 million tons in 2008 (figure 3). EuPR currently consists of 45 member companies and 6 associated organizations. All together they signify 80% of the recycling capacity in Europe. They focus on the promotion of plastics recycling and the creation of conditions which enable profitable and sustainable business. (European Plastics Recyclers 2010.)

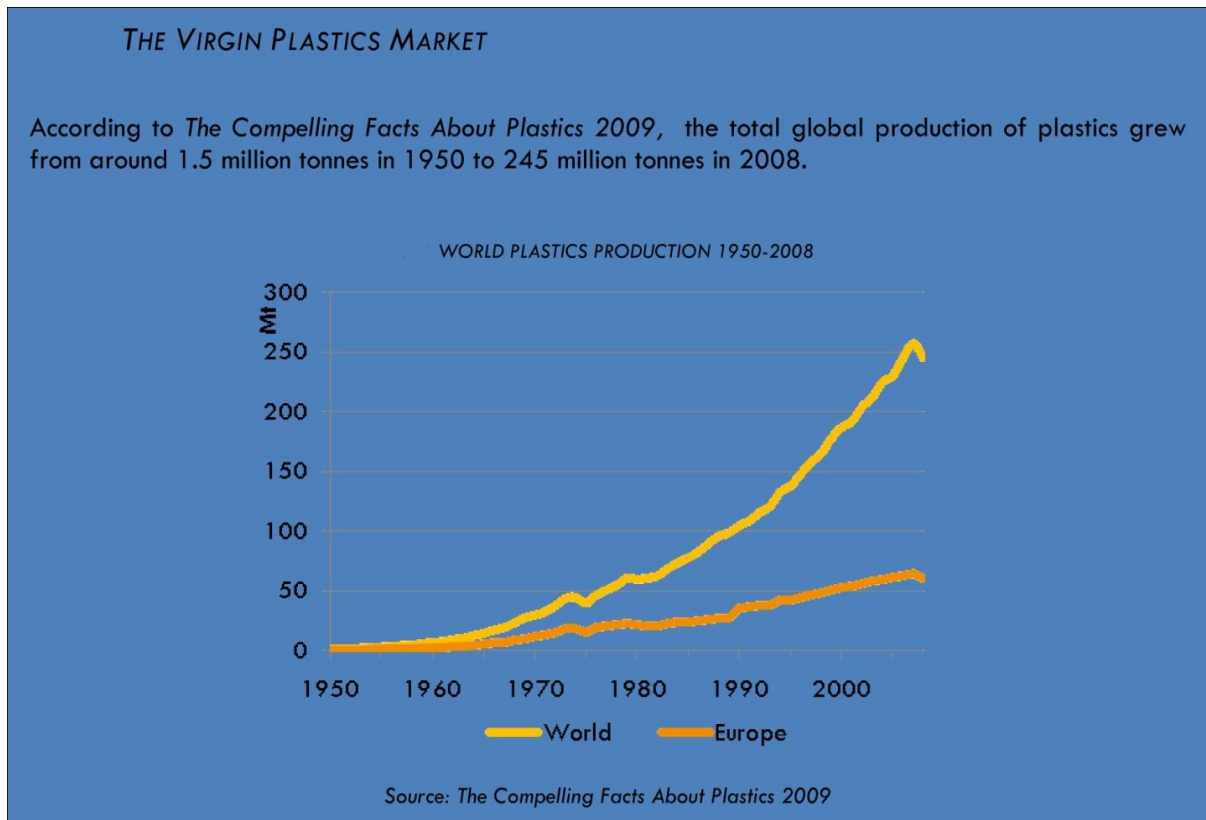

FIGURE 4. World plastics production between years 1950- 2008

Since 1950, the plastics consumption has increased dramatically, after 2000 the European consumption was more than 50 tons per year (figure 4). Nowadays, due to the environment protection and government's encouragement to reduce plastics waste, many companies around the world specialized in producing raw material plastics from the existing plastics waste. The European plastics mechanical recycling industry is moderately new industry, comprising more than 1000 companies employing approximately 30,000 people.

## **6. BIO-DEGRADABLE PLASTICS**

### **6.1 Bio-degradable**

Bio-degradable is degradation caused by biological action, mainly by enzyme action resulting in significant changes in the organic materials structure. The enzymes produced by living microorganisms break down the organic substances of the materials. The organic materials degradation can be carried by oxygen and then it is called aerobic degradation or without oxygen and it is called anaerobic degradation. (Happer 1999, 7-12.)

### **6.2 Bio-polymers**

Bio-polymers are synthesis polymers or plastics derived from natural renewable resources. Such renewable resources are corn starch, soy, etc. On the other hand, the habitual plastics are derived from petroleum sources can be modified to become biodegradable plastics to meet the performance necessities of its anticipated function. Many natural biodegradable plastics are blended with synthetic polymers to produce plastics which meet up the required functions.

At the moment plastics are largely made from crude oil. Nevertheless, the increasing demand for energy worldwide and the political instability in the large oil producing countries have increased the price of oil in latest years. In this situation, renewable resources are becoming more promising options for the plastics industry. (McCarthy 1993, 22-27.)

### **6.3 Advantages**

Bio-plastics consume almost 80% of the energy required to produce a traditional polymer. It will reduce the dependence on the oil.

Bio-polymers are much friendlier to the environment; these bio-materials break down faster. They have a shorter effect on the earth, on which they will degrade and disappear completely. They are very safe, and they contain no toxins. (Italian bio-plastic manufacturer Novamont 2010.)

#### **6.4 Application of Bio-polymers (bio-thermoplastics)**

Bio-polymer could be used in almost the same applications as normal polymers. Bio-thermoplastics or thermoplastics starch are the most significant and commonly used bio-plastic. Pure starch has the characteristic of being capable of absorbing humidity. That is why it is used for the production of drug capsules in the pharmacy area.

Some additives and plasticizer are added to starch in order to be processed thermoplastically. By changing the amounts of the additives, the characteristic of the material can be customized to specific needs in all industries field.

The common know applications are: packing, medicine, food industry, automobile industry, agriculture, mobile phones, etc. As an example Nokia is planning to introduce more products using bio-plastics and to develop material without compromising quality and technical standards. (Nokia 2010.)

#### **6.5 Ethical issues**

There are millions of people around the world suffering from hunger. It is inconvenient that the western countries produce millions tons of food corps used for bio-plastics. Many forests will be cut down to produce more corps to be used for bio-polymer raw material.

The manufacturers of raw material are aware of these embarrassing issues. But still there is hope coming from the Imperial College London, a team of Engineering and Physical Sciences Research Council (EPSRC) scientists led by Dr Charlotte Williams, they produce degradable polymers made from sugars known as lignocelluloses biomass. It comes from non-food crops such as fast growing trees and grass.

## **7. MANUFACTURING THE PRODUCT**

### **7.1 Injection molding background**

The injection molding technique was invented in 1868 by a man named John Wesley Hyatt. He was the first person to inject hot celluloid into a shape (mold), and the result was billiard balls as a replacement material for ivory. Along with his brother, they received a patent for the first injection-molding machine. The industry progressed slowly over the years, producing products such as collar stays, buttons, and hair combs. The industry expanded rapidly in the 1940s because World War II created a huge demand for inexpensive, mass-produced products. In 1946, American inventor James Watson Hendry built the first screw injection molding machine, which allowed much more precise control over the speed of injection and the quality of articles produced. This machine also allowed material to be mixed before injection, so that colored or recycled plastic could be added to virgin material and mixed thoroughly before being injected.

Today screw injection machines account for the vast majority of all injection machines. (<http://www.southwestplastics.com/learn-more/a-brief-history-of-plastic-injection-molding-process> Injection molding)

#### **7.1.1 Injection molding machines (IMM)**

IMM is one way of processing thermoplastics to produce different shapes. The IMM has in general three main sections: Injection, mold and clamping section (figure 5).

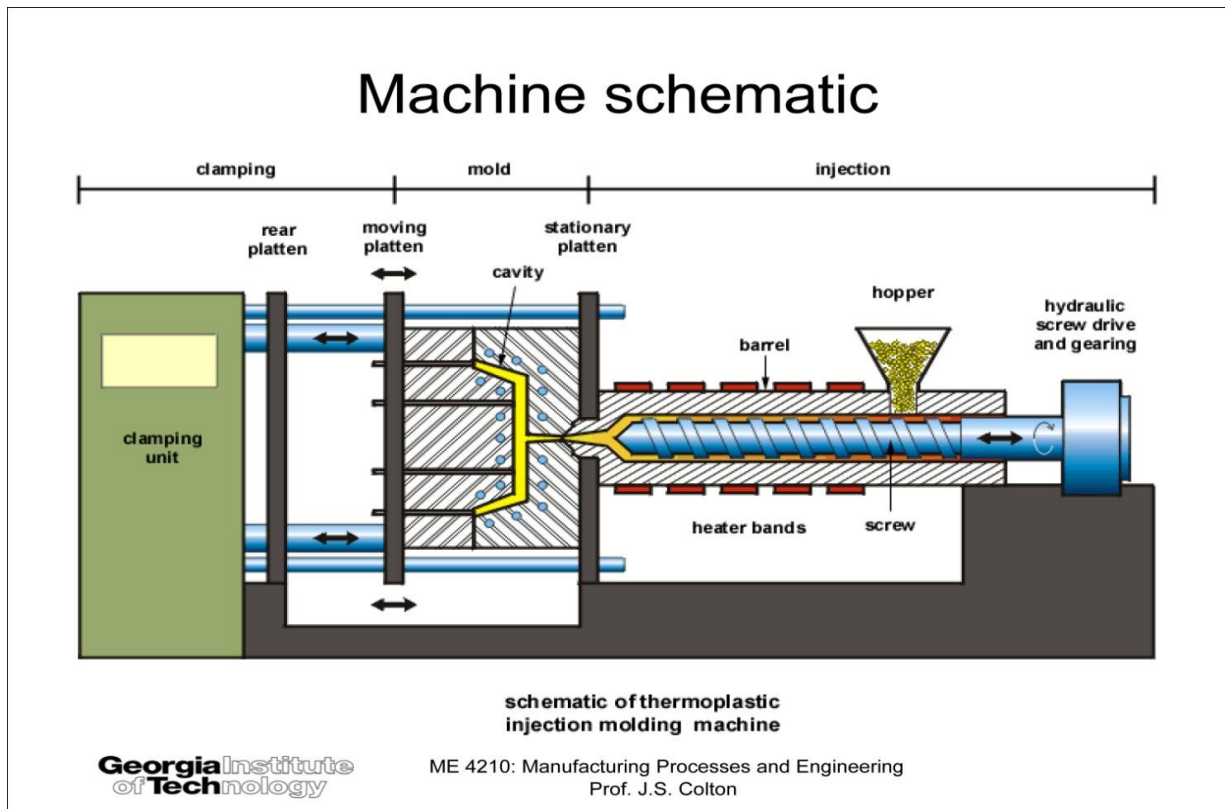

FIGURE 5. Injection molding schematic machine (Colton.)

The process in IMM starts with a mold, which is closed under pressure or clamping force, next resins are fed into the machine through the hopper loader. After that resins fall into an injection barrel, where they are heated to a melting stage, and then injected into the mold. An appropriate hydraulic or mechanical pressure is applied to make sure all of the cavities within the mold are packed or filled. The molten plastic is cooled within the mold, which is then opened by separating the two halves of the mold. As a final step the plastic product or part is ejected from the mold with the help of ejector pins within the mold. This process is called the cycle time. Small parts have a small cycle time; big parts have a larger cycle time. (Summer work in rinotop OY 2009.)

The process of IMM is shown in Figure 6, Figure 7

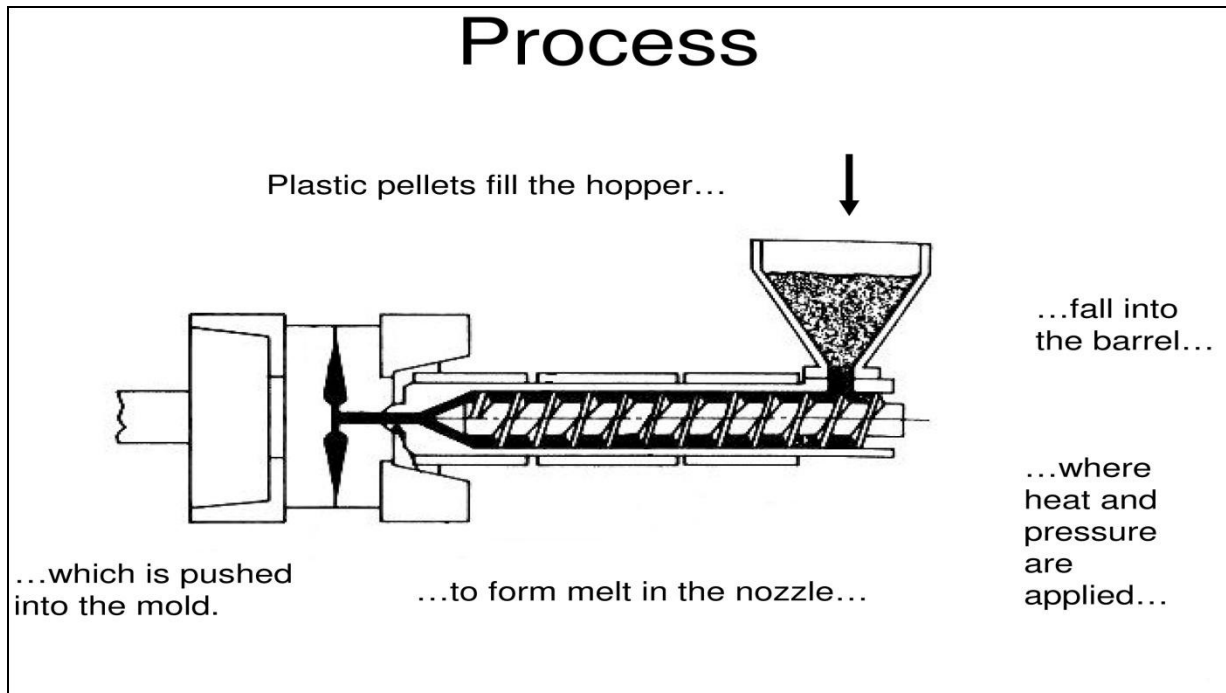

FIGURE 6. Injection molding part production cycle (Anderson & Atkins.)

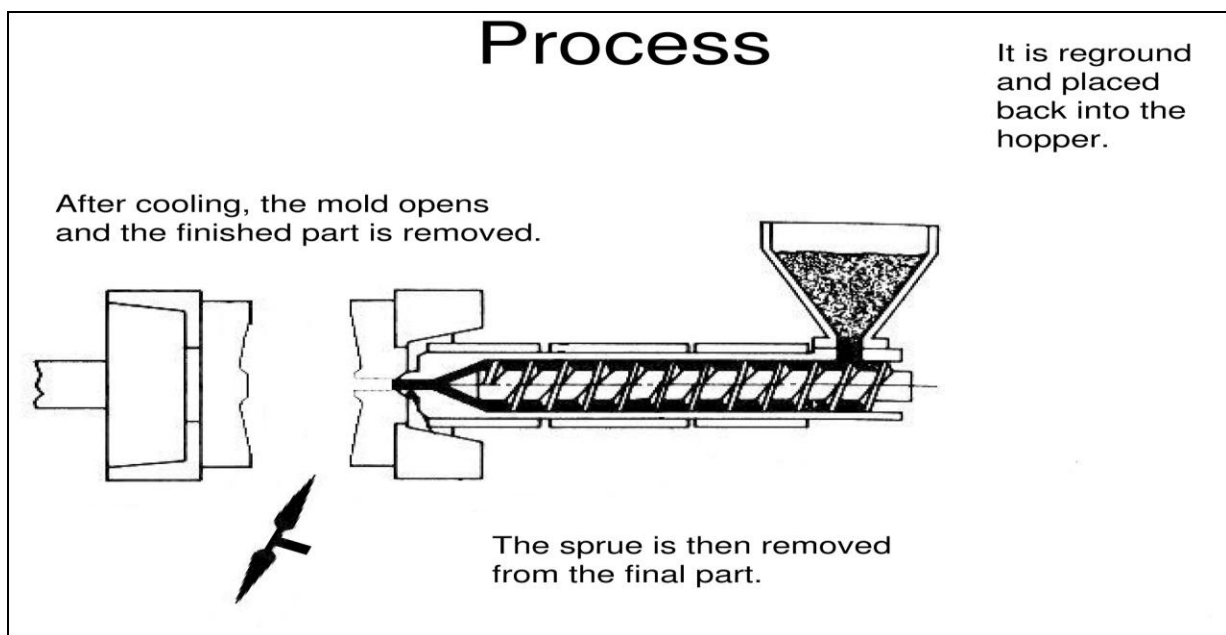

FIGURE 7. Injection moulding part production cycle (Anderson & Atkins.)



### **7.1.2 Injection molding machines manufacturers**

Nowadays there are so many manufacturers of the injection molding machines. Such well known manufacturers in Finland are: Engel (Austria), Krauss Maffei (German), and BOY (German). They are also the world wide pioneers in injection molding machines. (Summer work Bowtec OY 2008.)

### **7.2 Characteristics of injection molding machine**

Injection molding machines are defined according to their shot capacity. A shot represents the maximum volume of melt that is injected into the mold. It is usually about 30 to 70% of the actual available volume in the plasticator. The difference basically relates to the plastic material's melt behavior, and provides a safety factor to meet different mold packing conditions. Shot size capacity may be given in terms of the maximum weight that can be injected into one or more mold cavities; a better way to express shot size is in terms of the volume of melt that can be injected into a mold at a specific pressure. The injection pressure in the barrel can range from 14 to 205 MPa. The characteristics of the plastic being processed determine what pressure is required in the mold to obtain good products. Given the required cavity pressure, the barrel pressure has to be high enough to meet pressure flow restrictions going from the plasticator into the mold cavity or cavities. The clamping force on the mold halves required in the IMM also depends on the plastic being processed. A specified clamping force is required to retain the pressure in the mold cavity or cavities. It also depends on the cross sectional area of any melt located on the parting line of the mold, including any cavities and mold runner(s) that are located on the parting line. By multiplying the pressure required on the melt and the melt cross-sectional area, the clamping force required is determined. To provide a safety factor, 10 to 20% should be added. (Rosato 2000, 4)

## 8. DESIGNING THE PRODUCT

### 8.1 Solid Edge

There are many designing software available nowadays in the market with different prices. Designing engineers and companies are using the cheapest and user-friendliest programs. Solid Edge will be used to design and run some analysis on the touch screen pen.

Solid Edge is an industry-leading mechanical design system with exceptional tools for creating and managing 3D digital prototypes. With superior core modeling and process workflows, a unique focus on the needs of specific industries, and fully integrated design management, Solid Edge guides projects toward an error free, accurate design solution. Solid Edge modeling and assembly tools enable the engineering team to easily develop a full range of products, from single parts to assemblies containing thousands of components.

Tailored commands and structured workflows accelerate the design of features common in specific industries and ensure accurate fit and function of parts by designing, analyzing and modifying them within the assembly model. ([http://www.plm.automation.siemens.com/en\\_us/products/velocity/solidedge/overview/index.shtml](http://www.plm.automation.siemens.com/en_us/products/velocity/solidedge/overview/index.shtml))

Solid Edge is the only mainstream mechanical system that merges design management capabilities with the CAD tools that designers use every day. Solid Edge customers have a choice of scalable product data management solutions that manage designs as quickly as they are created. Practical tools for managed collaboration help to coordinate design team activities better and remove the errors that result from miscommunication. Product and process complexity is a growing concern for manufacturing organizations.

Thousands of companies around the world have come to rely on Solid Edge to battle this increasing complexity head-on. Taking the advantage of Solid Edge's powerful design with insight approach, they are first to benefit from the CAD industry's most functional innovations, first to complete their designs, and first to market with an error

free product..([http://www.plm.automation.siemens.com/en\\_us/products/velocity/solid-edge/overview/index.shtml](http://www.plm.automation.siemens.com/en_us/products/velocity/solid-edge/overview/index.shtml))

## 8.2 Master cam

Master cam is one of the most powerful programs in designing moulds for the injection molding machines. Usually there is a readymade standard mold, the only thing which changes is the cavities, sprue, ejector plates, ejector pins, and runners. With the help of master cam a G-code and m-codes are generated and then imported to the CNC (computer numerical control) machine to produce the mold cavities, sprue, and ejector plates.

## 8.3 G-codes and M-codes

There are two major types of CNC codes, or letter and number addresses, in any NC (numerical control) program. The main CNC codes are called G-codes and M-codes. G-codes are foundation functions, which engage definite tool moves and control the machine. These functions include rapid moves, feed moves, radial feed moves, dwells, roughing, and profiling cycles. Some major G-codes are presented in the table 2:

TABLE 2. Some G codes list for CNC machine (ANILAM 2006, 43)

Modal		Non-Modal	
G-Code	Function	G-Code	Function
<b>G0</b>	Positioning-Rapid Traverse	<b>G4</b>	Dwell
<b>G1</b>	Linear Interpolation-Feed	<b>G5</b>	Ellipse
<b>G2</b>	Circular Interpolation-CW	<b>G9</b>	Exact Stop Check
<b>G3</b>	Circular Interpolation-CCW	<b>G28</b>	Return to Machine Home
<b>G22</b>	Stored Stroke Limit ON	<b>G29</b>	Return from Machine Home
<b>G40</b>	Tool Radius Compensation, Cancel	<b>G31</b>	Probe Move
<b>G41</b>	Tool Radius Compensation (Left)	<b>G45</b>	Mold Rotation
<b>G42</b>	Tool Radius Compensation (Right)	<b>G49</b>	Elbow Milling
<b>G53</b>	Work Coordinate System	<b>G62</b>	Automatic Feed Override for Arcs
<b>G59</b>	Modal Corner Rounding	<b>G63</b>	Automatic Feed Override for Arcs Cancel
<b>G60</b>	Modal Corner Rounding Off	<b>G65</b>	User Macro Single Call
<b>G61</b>	Exact Stop Check Mode	<b>G66</b>	User Macro Modal Call
<b>G64</b>	Cutting Mode (Continuous Path ON)	<b>G67</b>	User Macro Modal Call Cancel
<b>G66</b>	User Macro Modal Call	<b>G68</b>	Coordinate System Rotation
<b>G67</b>	User Macro Modal Call Cancel	<b>G73</b>	Draft Pocket Milling Cycle
<b>G68</b>	Coordinate System Rotation	<b>G75</b>	Frame Milling
<b>G70</b>	Inch Programming	<b>G76</b>	Hole Milling Cycle
<b>G71</b>	MM Programming	<b>G77</b>	Circular Pocket Cycle
<b>G72</b>	Axis Scaling	<b>G78</b>	Rectangular Pocket Cycle
<b>G90</b>	Absolute Programming	<b>G79</b>	Bolt Hole Circle Cycle
<b>G91</b>	Incremental Programming	<b>G80</b>	Cancel Modal Drilling

## 8.4 M-codes

M-codes are miscellaneous functions, which represent necessary actions. These functions include actions such as spindle on and off, tool changes, coolant on and off, program stops. Some major M codes are in the table 3:

TABLE 3. Some M-codes list for CNC machine (ANILAM 2006, 226.)

<b>M-Code</b>	<b>Function</b>
<b>M0</b>	Program stop.
<b>M2</b>	End of program.
<b>M3</b>	Spindle ON FWD.
<b>M4</b>	Spindle ON REV.
<b>M5</b>	Spindle OFF.
<b>M8</b>	Coolant ON.
<b>M9</b>	Coolant OFF.
<b>M30</b>	Jump to new program.
<b>M98</b>	Call subprogram.
<b>M99</b>	End subprogram.
<b>M100</b>	Mirror image.
<b>M105</b>	Dry-run, all axes.
<b>M106</b>	Dry-run, NO Z axis.
<b>M107</b>	Dry-run off (cancels M105 or M106).

## 8.5 CNC machine

Computer Numerical Control CNC machine is one in which the functions and movement of a machine tool are controlled with the help of a program containing codes and data. Therefore it controls the movement of the work piece and machining tool to achieve a determinate task. (Arcada UAS lab work December 2010.)

### 8.5.1 Advantages

The benefits of CNC are:

Short production time

High accuracy in manufacturing

Greater manufacturing flexibility

Easy changing of tools

Reduce risk of human error.

### 8.5.2 Disadvantages

High costs

Maintenance

Requirement of skilled programmers

### 8.5.3 Elements of a CNC machine

A CNC system consists of three basic components (FIGURE 8)

Part program

Machine Control Unit (MCU)

Machine tool

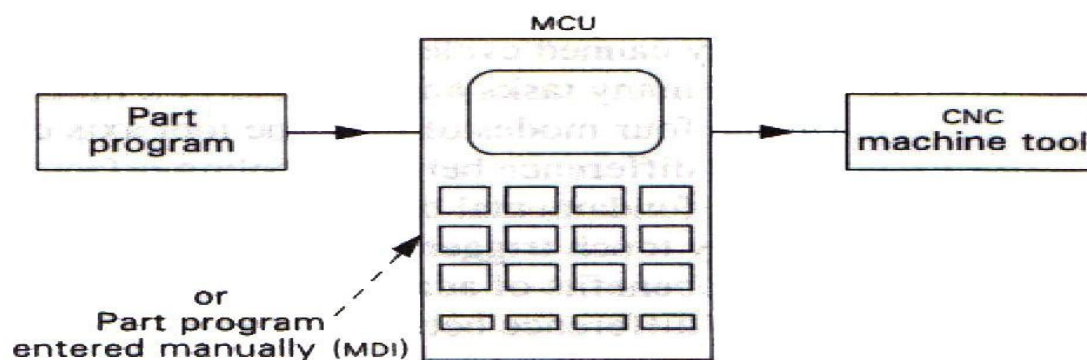

FIGURE 8. CNC machine Control Unit (waters 1996, 242.)

#### 8.5.3.1 Part program

The part program is the language or sort of a set of commands to be followed by the machine tool to carry such determined task. These sort of commands are known as G-codes and m-codes language. The set of commands specifies the movement of the tool over the working piece. The commands to the tool can refer to the depth of cuts, speed spindle, feed rate and the position of the tool on the x-axis, y-axis and z-axis. The part program is written manually or by using computer assisted language such as Master Cam. (Arcada UAS lab work December 2010.)

### 8.5.3.2 Machine Control Unit (MCU)

It represents a sophisticated electronic controller attached to the CNC machine. The MCU translates the part program into electrical signals, which are then sent to the machine tool elements. Many other functions can be performed by MCU such as a complex calculation related to the tooling offset, cutter path, automatic tool changing, coolant control, etc.

The MCU nowadays has the ability to detect systems faults and recommend the most appropriate corrective action. (waters 1996, 249.)

The most sophisticated MCUs have a screen monitor which enables the user to run a simulation and follow the machining task, figure 9.



FIGURE9. MCUs have screen monitor

([http://www.fidia.it/download/brochure/classe\\_c\\_it.pdf](http://www.fidia.it/download/brochure/classe_c_it.pdf))

### 8.5.3.3 Machine Tool

The machine tools are classified either as machining centers which are CNC milling or as turning centers which are CNC lathe. However, a CNC milling or CNC lathe are just conventional machines with an MCU attached to them. (waters 1996, 255.)

## 9. DESIGN PROCESSING

### 9.1 Product design

The most common stylus pens in the market have the shape as shown in the figure 10:

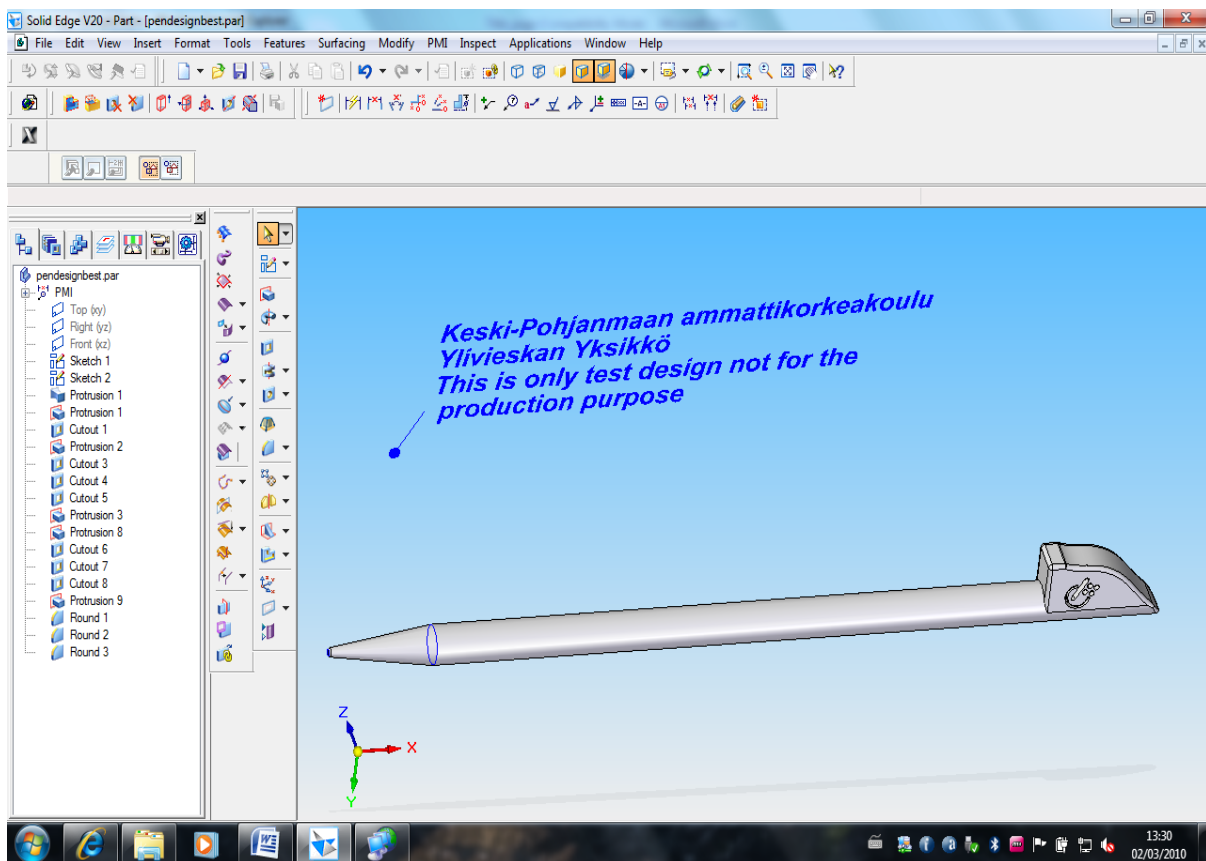

FIGURE 10. Test design for touch screen pen

Since there are already many stylus pen products in the market, it is forbidden to produce similar existing ones. Therefore according to the patent rules and copy right, the new touch screen will have a different look and shape. Using the solid edge as designing program, the new product is shown in the Figure 11:

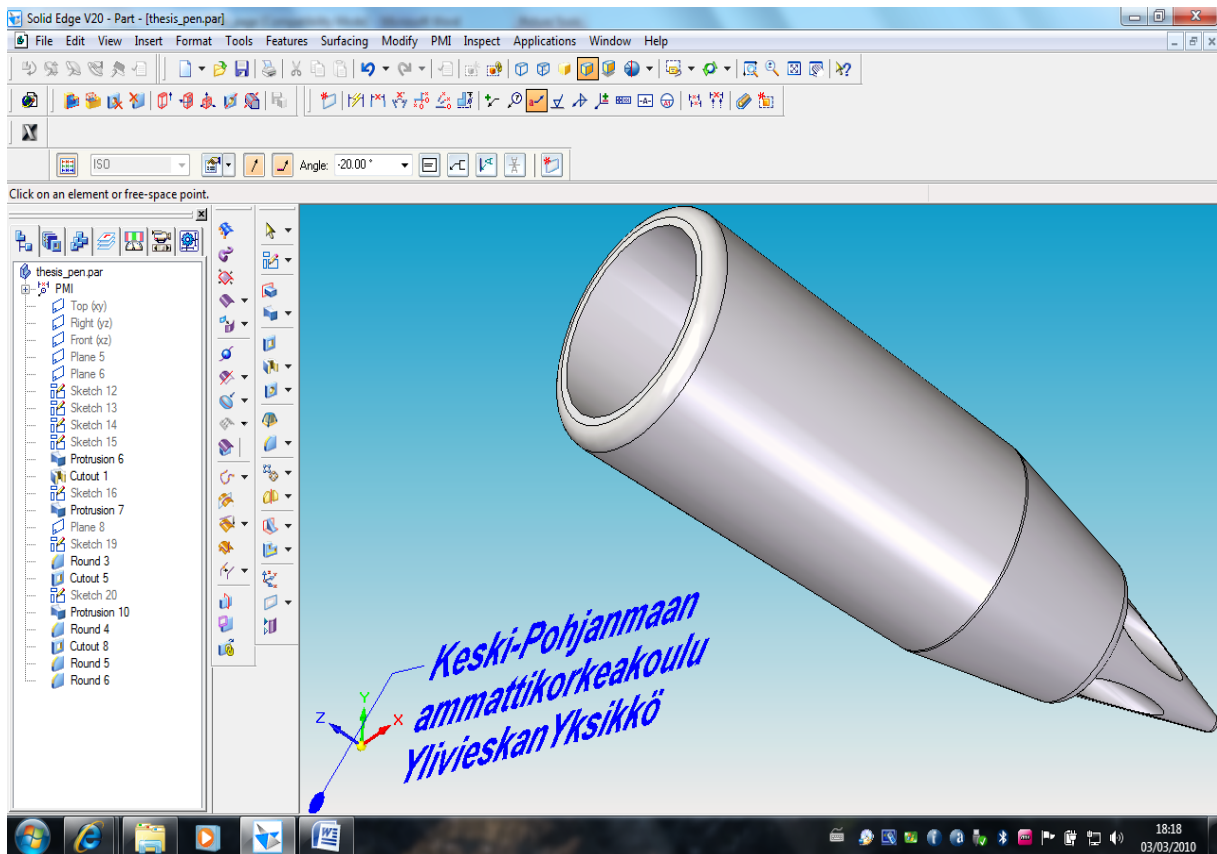

Figure 11. New touch screen product design

As the figure 11 the new product has a shape of the cone at the end and the hollow cylinder shape on the top of the cone. The hollow cylinder permits the touch screen users to plug or connect the product in any regular writing pen or pencil with an enabling the users to navigate freely on the screen of their devices.

## 9.2 Measurements

The diameter of the most used pens range between 8mm and 12mm. Therefore the product is coming in two samples. Sample A and sample B. The sample A can be used with a pen or pencil with larger diameter between 12 mm to 10 mm. The sample B can be used with a pen or pencil with smaller diameter between 8mm to 10 mm.

### 9.2.1 Sample A

The hollow cylinder top part of the product A is 25 cm high. The top inner diameter of the hollow cylinder is 11mm. The top outer diameter is 14 mm and the top thickness is 1.5 mm.



The bottom inner diameter of the hollow cylinder is 10 mm. The bottom outer diameter is 12 mm and the bottom thickness of the hollow cylinder is about 2 mm at the top of the product, due to the rounding of the outer diameter in order to avoid sharp edges. The hollow cylinder is designed in a way to help the ejection of the product from the mold, preventing the product from stacking in the mold cavities. The dimension of the diameter in the top and bottom of the cylinder are set in order to use lofted option when building the solid hollow cylinder in solid edge program. The top and the bottom diameters are sketched in different planes, as shown in the figure 12 and figure 13. (Units are in millimeters).

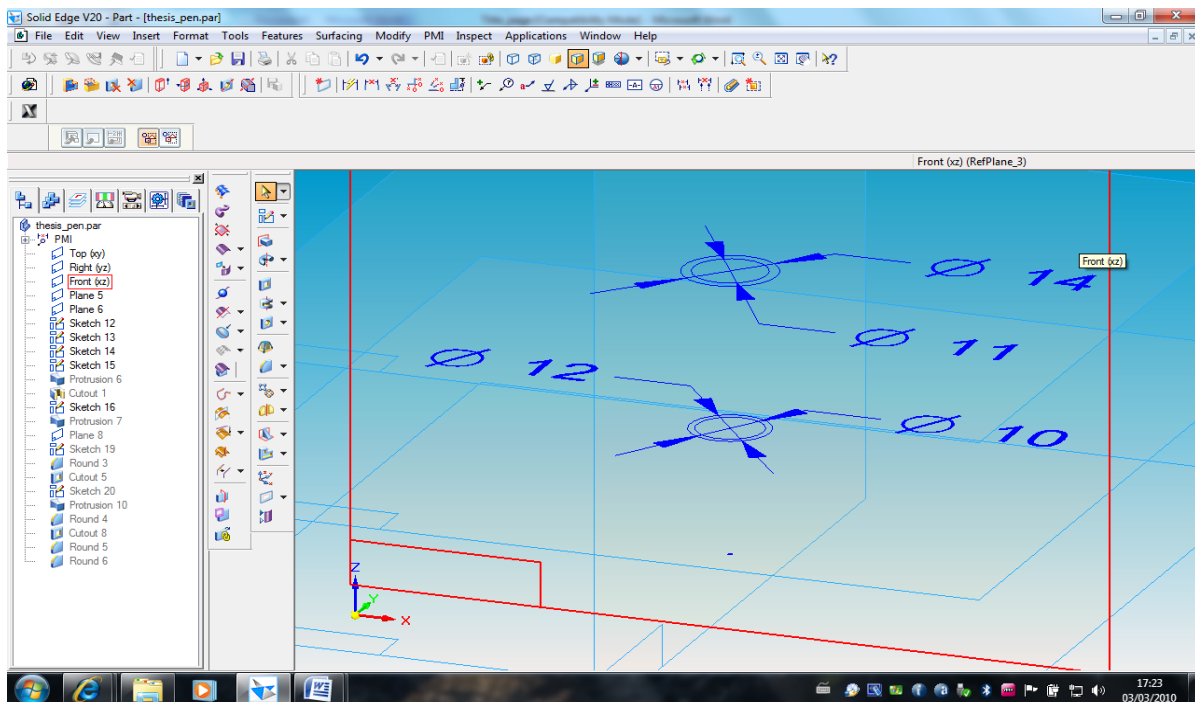

FIGURE 12. The sketch of top and bottom diameters of the product sample A

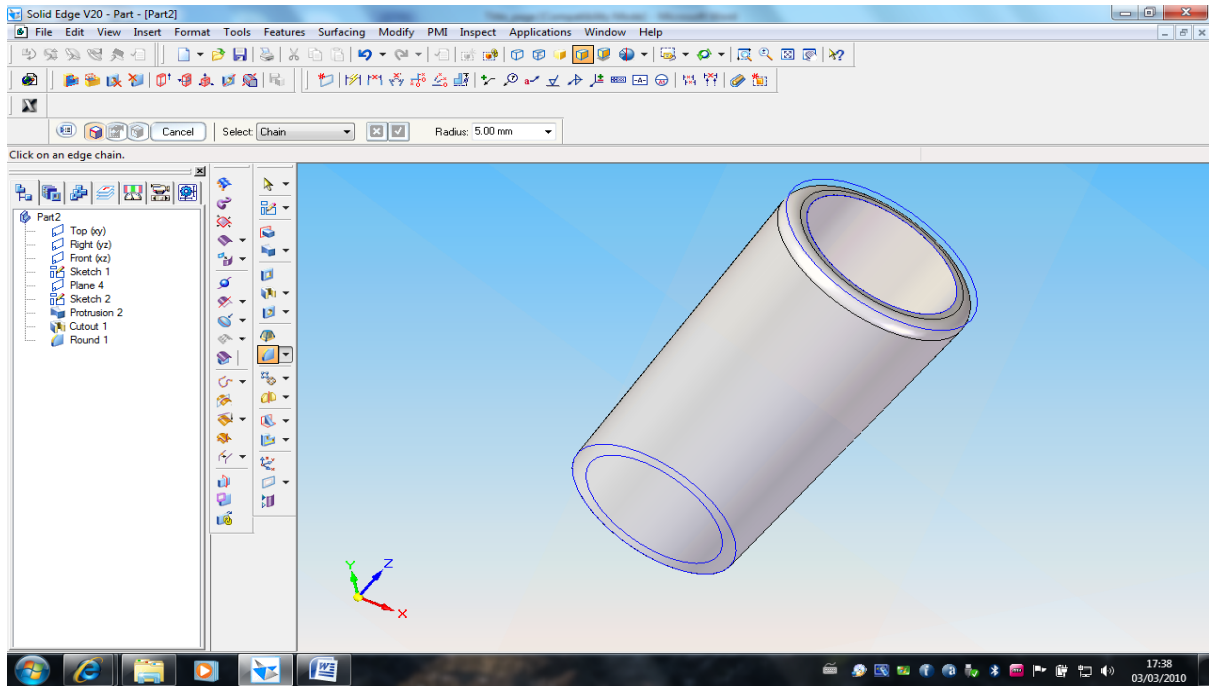

Figure 13. The 3-D shape of the product sample A cylinder

The cone head of the product is designed in the similar way using the lofted option in solid edge to build the solid 3D material, Figure 14.

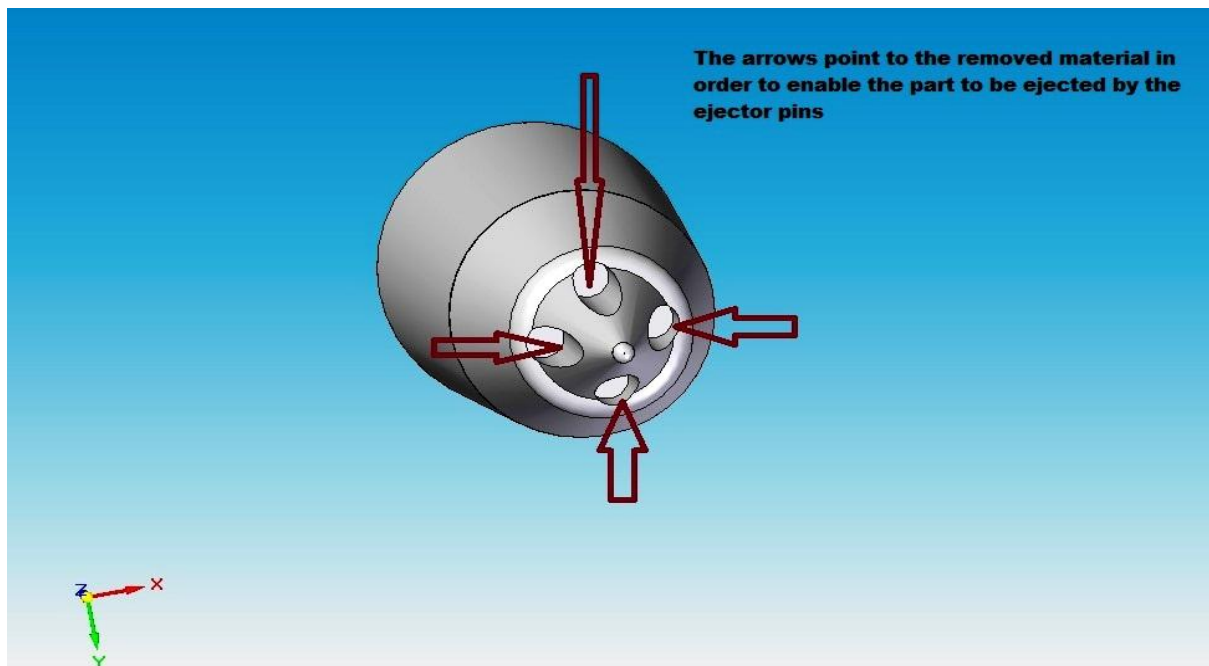

FIGURE 14. The cut out of the material from the cone head to enable the part to be ejected with ejector pins

The cut out of the material at the end of the sample A (just before the cone sharp rounded end head), represents the ejectors positions which enable the part to be ejected from the mold cavity.

### 9.2.2 Draft design sample A

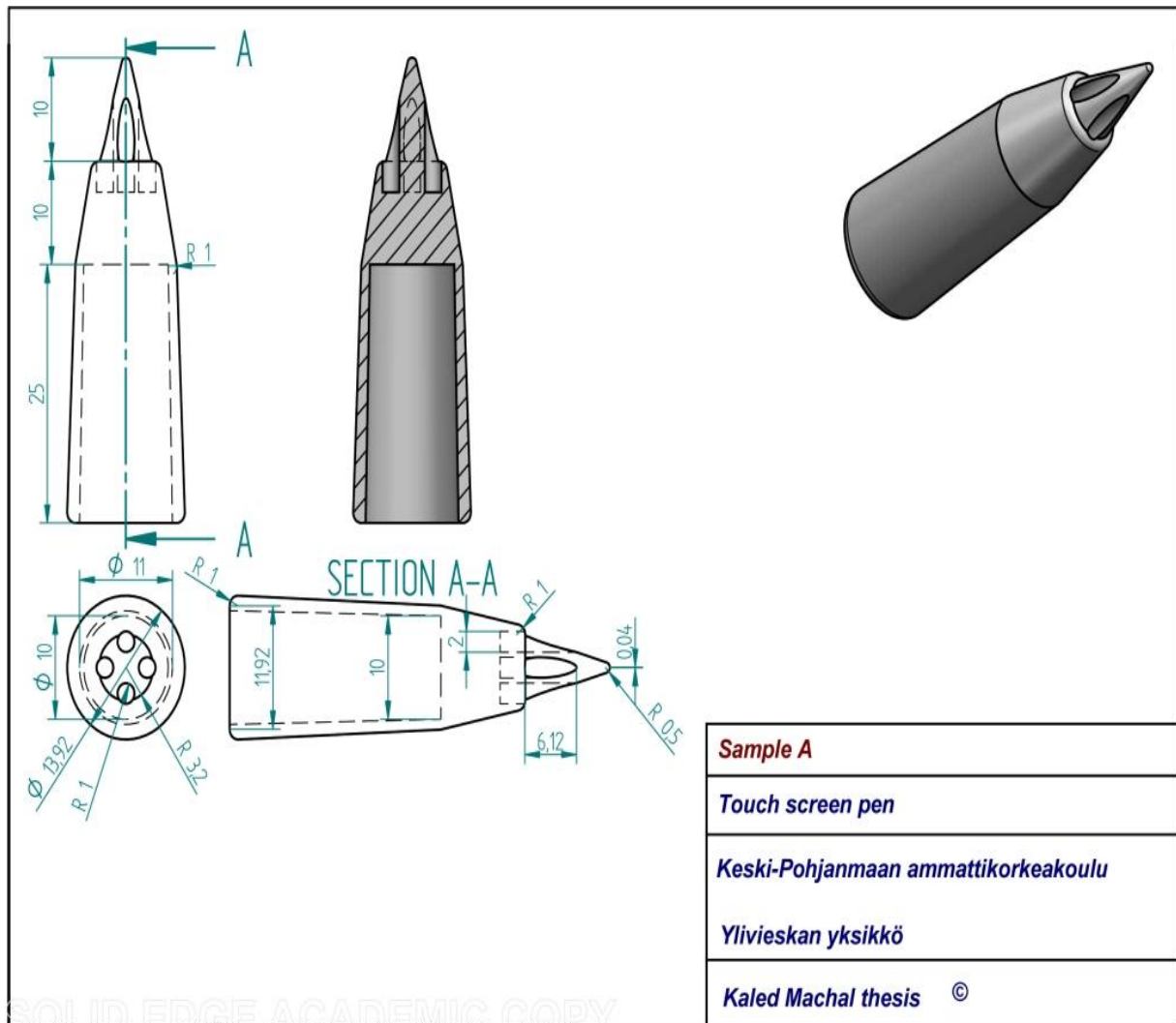

FIGURE 15. Draft design of the sample A

### 9.2.3 Draft design sample B

The sample B is quite similar to the sample A, only the dimensions are different; the sample B has the dimensions as shown on the draft in the figure 16.

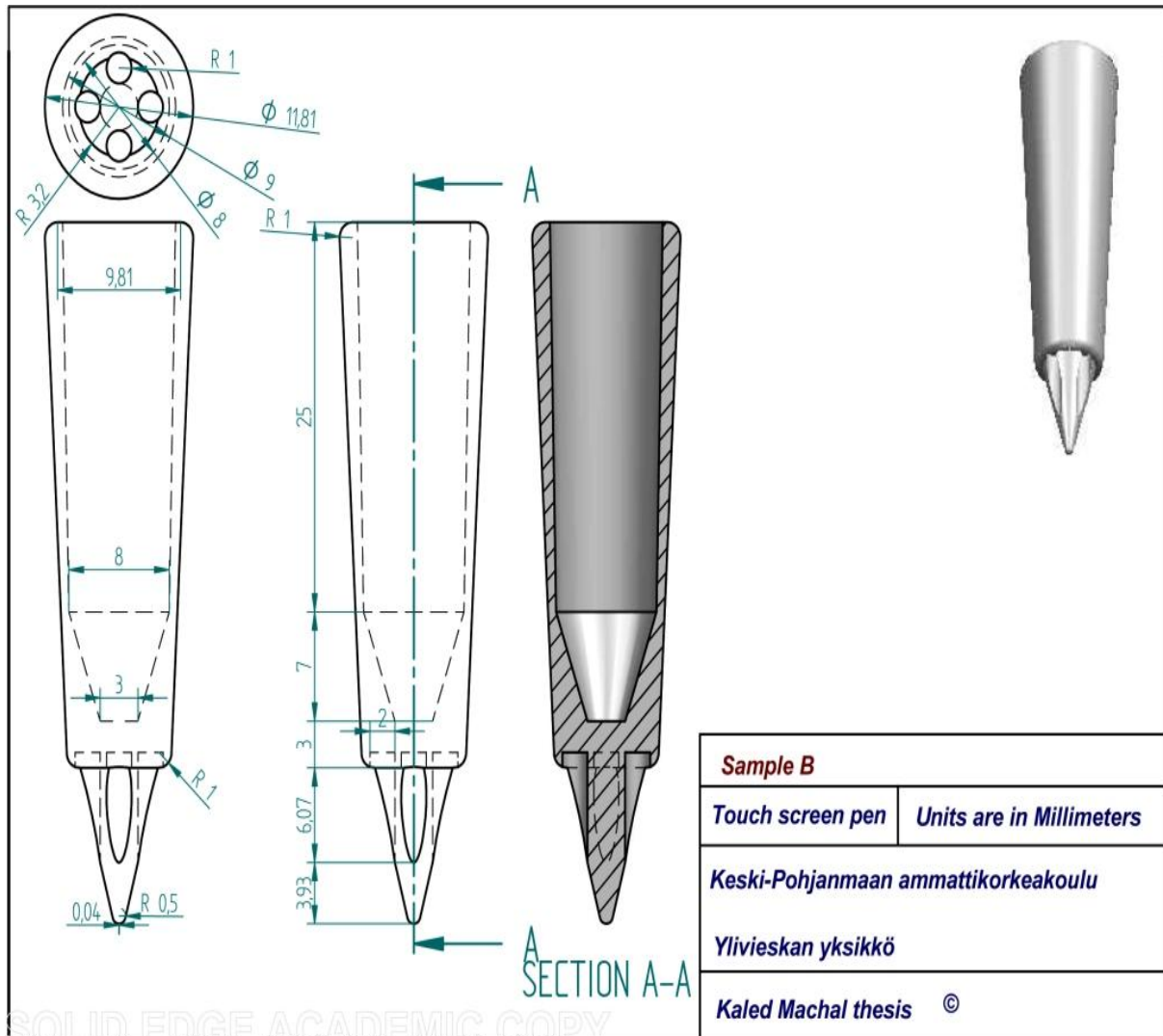

FIGURE 16. Draft design of the sample B

### 9.3 Samples A & B colors

It is evident that all consumers have different writing pen colors (the outlook of the writing pen color), or different touch screen devices with different colors, therefore the product should have an adequate color which would suit either the pen or the device or both. The product will have, for example, the following colors as shown in the table 3 and table 4.

TABLE 4. Available colors for the touch screen pen sample A and sample B











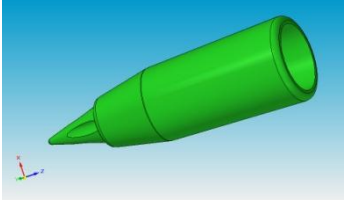
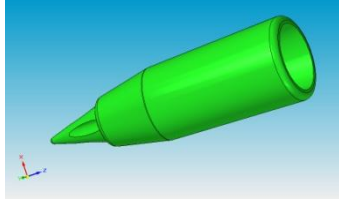
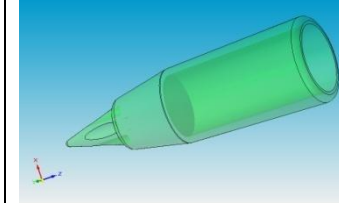
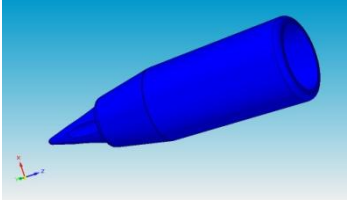

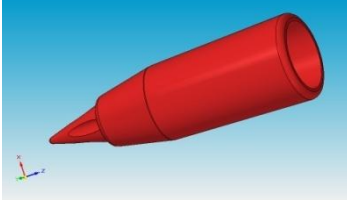
	Dull color	Normal color	Clear color
Green			
Blue			
Red			
Yellow			
White			
Black			

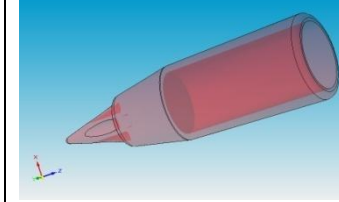
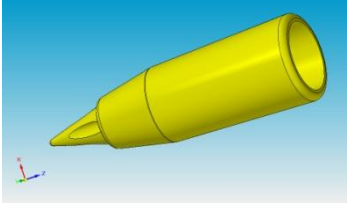
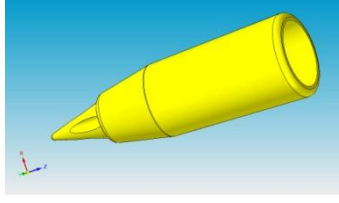
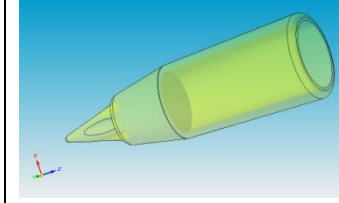
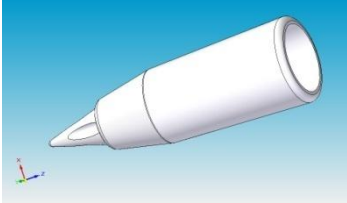
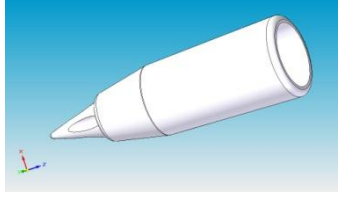
Table 5. Available colors for the touch screen pen sample A and sample B

		
Brass color	Bronze color	Cooper color
		
Gold color	Orange color	Tan color
		
Steel red hot color	Violet color	Cyan color
		
Teal color	Thread Color	Steel color

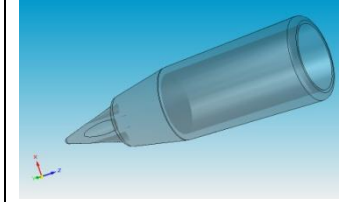
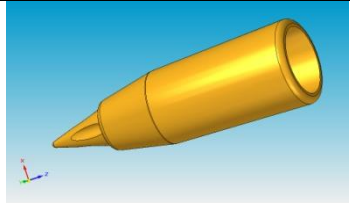
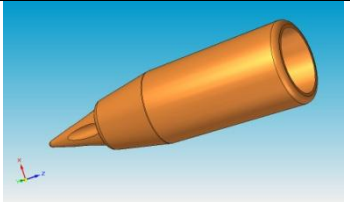
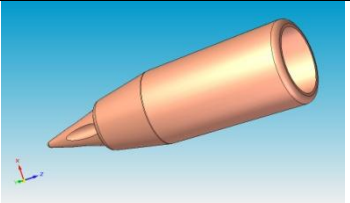
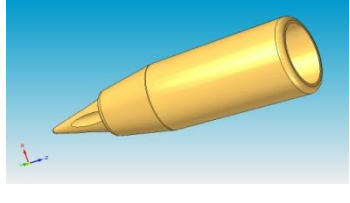
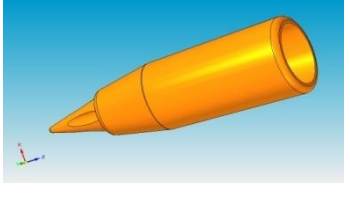
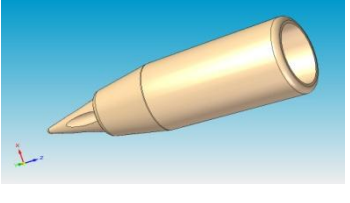
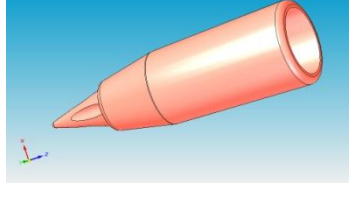
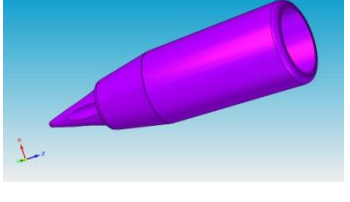
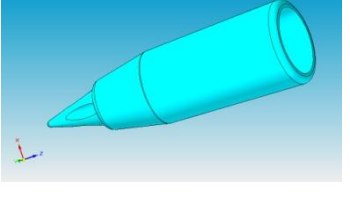
#### 9.4 Raw material

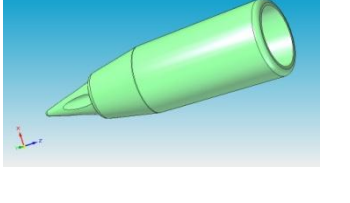
Environmentally Friendly, Eco-Friendly, Earth Friendly, and Nature Friendly describe intensive efforts and dedications to the environment and our planet Earth from many industries. It is time to start thinking in such a way. Consequently, the raw materials which should be used to fabricate the products shown in table 4 and table 5 are Recycled plastics granulate.

The recycled plastics fall usually in thermoplastics families as example: Polypropylene (PP), Polyethylene (PE), polyethylene terephthalate (PET), some additives, and 30% usually from the virgin plastics are added to the recycled plastics to ensure the optimal product quality.

There is few recycled plastics suppliers in Finland, L&T MUOVIPORTTI OY is the leading plastics recycling company in Finland, which has the main office and factory in Merikarvia. The company produces polypropylene, polyethylene and other type of recycled plastics. (<http://www.muoviportti.fi/english/index.htm>)

### **9.5 Bio-degradable plastics**

Nowadays there is a Variety of companies producing bio-plastics raw materials, many associations of bio-plastics are working side by side with government and consumers in terms of saving the planet Earth. A well known association is the Australian bio-plastics association. It consists of many members.

(<http://www.bioplastics.org.au/members.php>)

Some bio-plastics raw materials are: Polylactic acid (PLA), Polyamide 11 (PA 11), Poly-3-hydroxybutyrate (PHB) and Bio-derived polyethylene.

The product should be flexible. It can be easily plug in any kind of a writing pen or pencil. There are many raw material suppliers specialized in offering such material with specific characteristics. The producer only has to describe the properties of the product; the suppliers will find the right additives, fillers, colors, and masterbatches in order to achieve the best production quality.



## 10. MOULD DESIGN

After designing the product, an appropriate mold should be built in order to start producing a large number of product items. Many companies can provide their customers with standard mold components. The customer has to send to the mold makers the design of the cavities, runners and the ejector pins locations. All components in the standard mold are similar, the thing which changes is the so called the cavity plates, i.e. the plates which contain the parts cores and the ejector pins.

### 10.1 Cavity plate

The cavity plates represent the nest for the product part. The cavity will have four nests, or four cavities, each one representing one product. The cavity plate will have also the runners and gates from which the molten polymer will flow in the nest, in order to fill the nest with the appropriate amount of material. The runners will have a capital I shape or Romans number one shape (Figure 17), for the sample A.

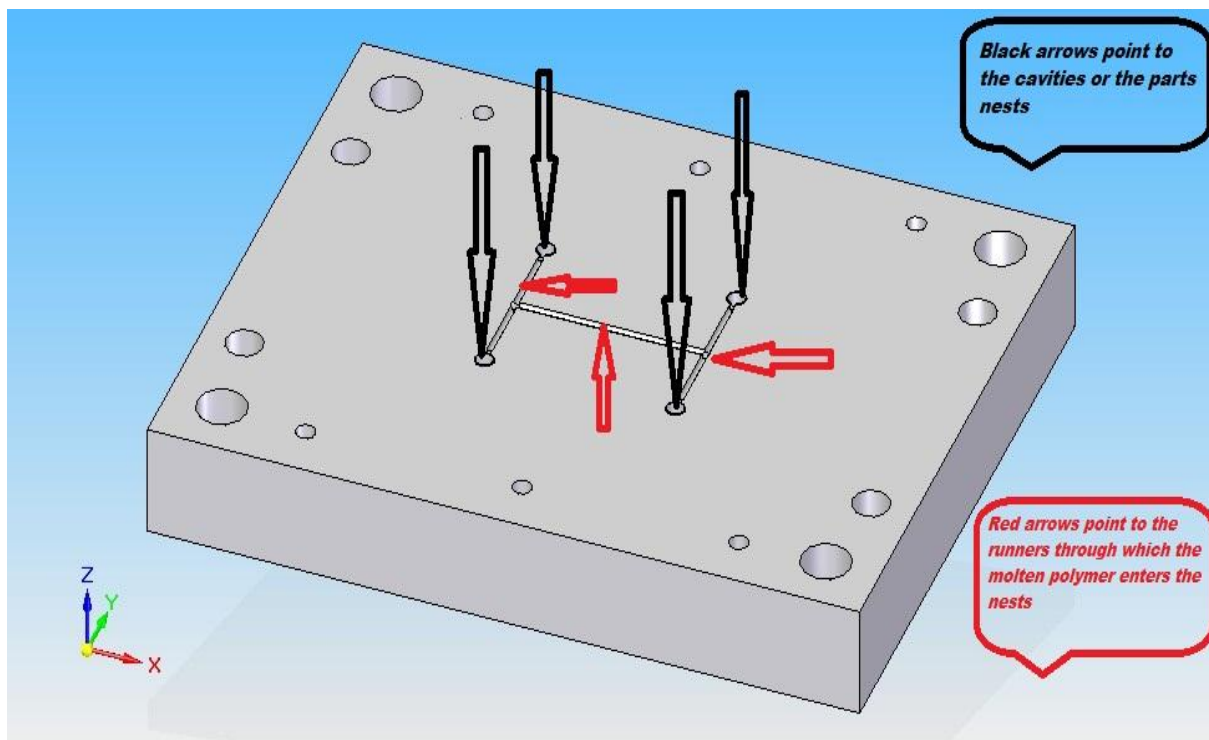



FIGURE 17. Cavity plate product sample A

## 10.2 Core plate

The core plate represents the mold plate which contains the product core. With the help of the core the inner shape of the part is enabled. The figure 18 shows the core plate for the sample A.

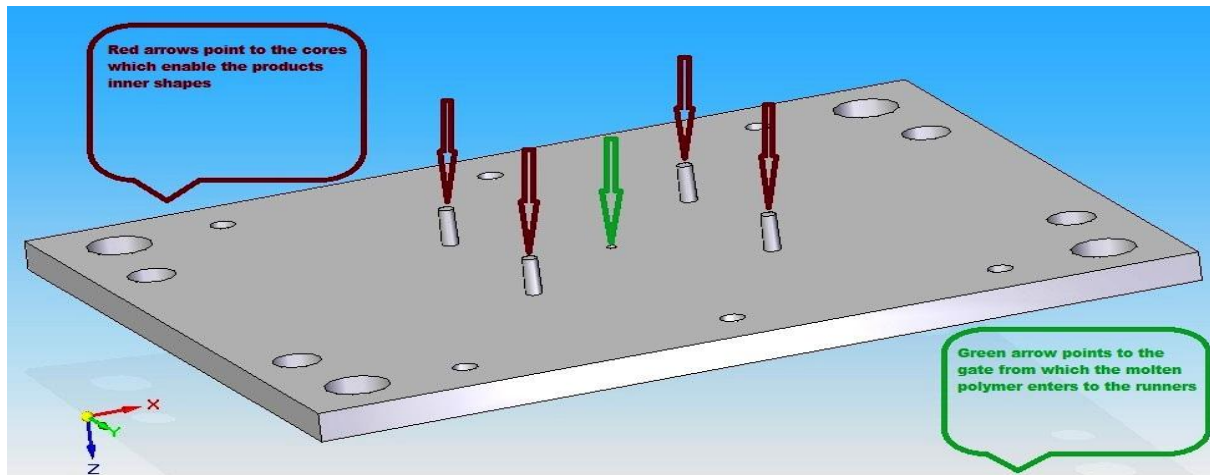

FIGURE 18. Core plate product sample A

## 11. Draft design

### 11.1 Draft cavity plate design sample A

The draft of the product cavity plate for the sample A is shown in the figure 19 which represents the isometric drawing of the cavity plate (sample A). However, in the drawing the small details are hidden due to the size of the part. The figure 20 will show the drawing of the half cut out of the inner nest or cavity of the sample A. The larger runner in the middle has a diameter of 5mm and 5 mm deep. The small runners have a diameter of 4mm and depth of 4mm. The gate section, through which the molten polymer enters the nest, is a rectangle of 3mm x 2mm and depth of 1.5 mm. The figure 23 will show the draft design of runners for both sample A and sample B.

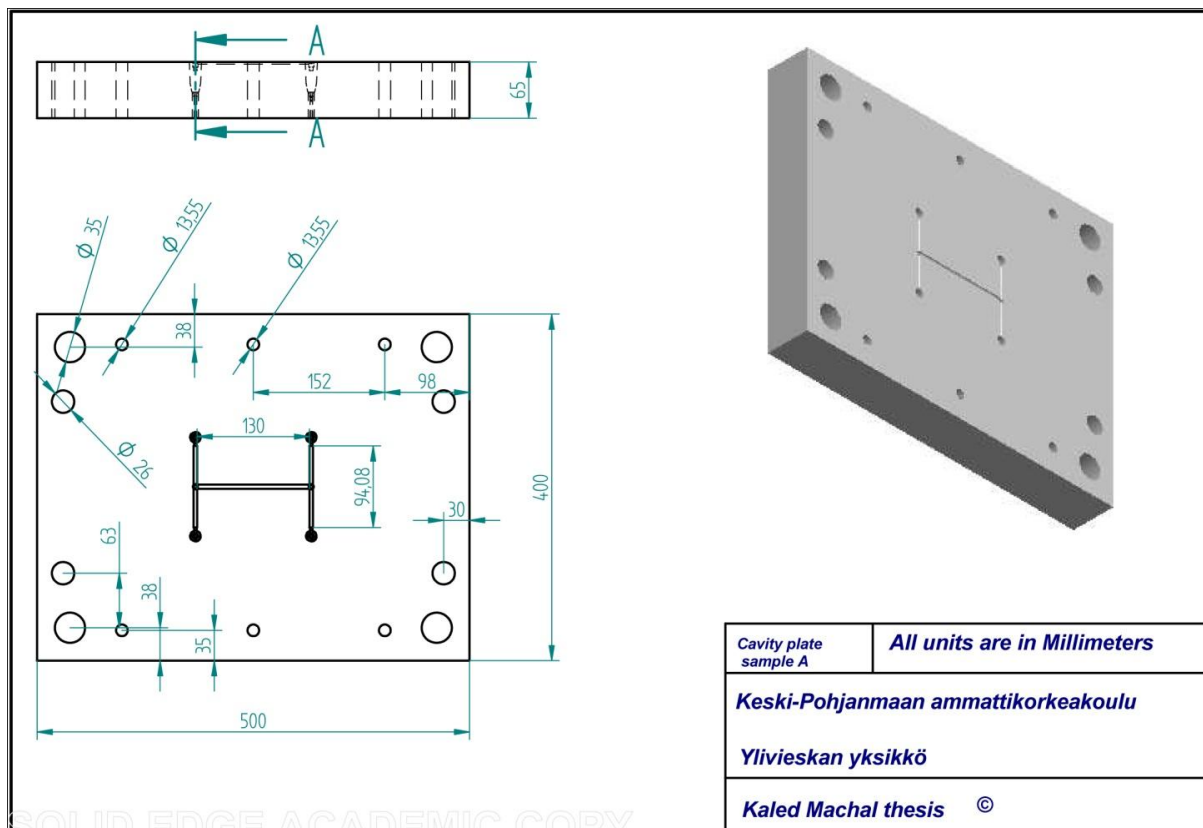

FIGURE 19. Isometric drawing of the cavity plate sample A

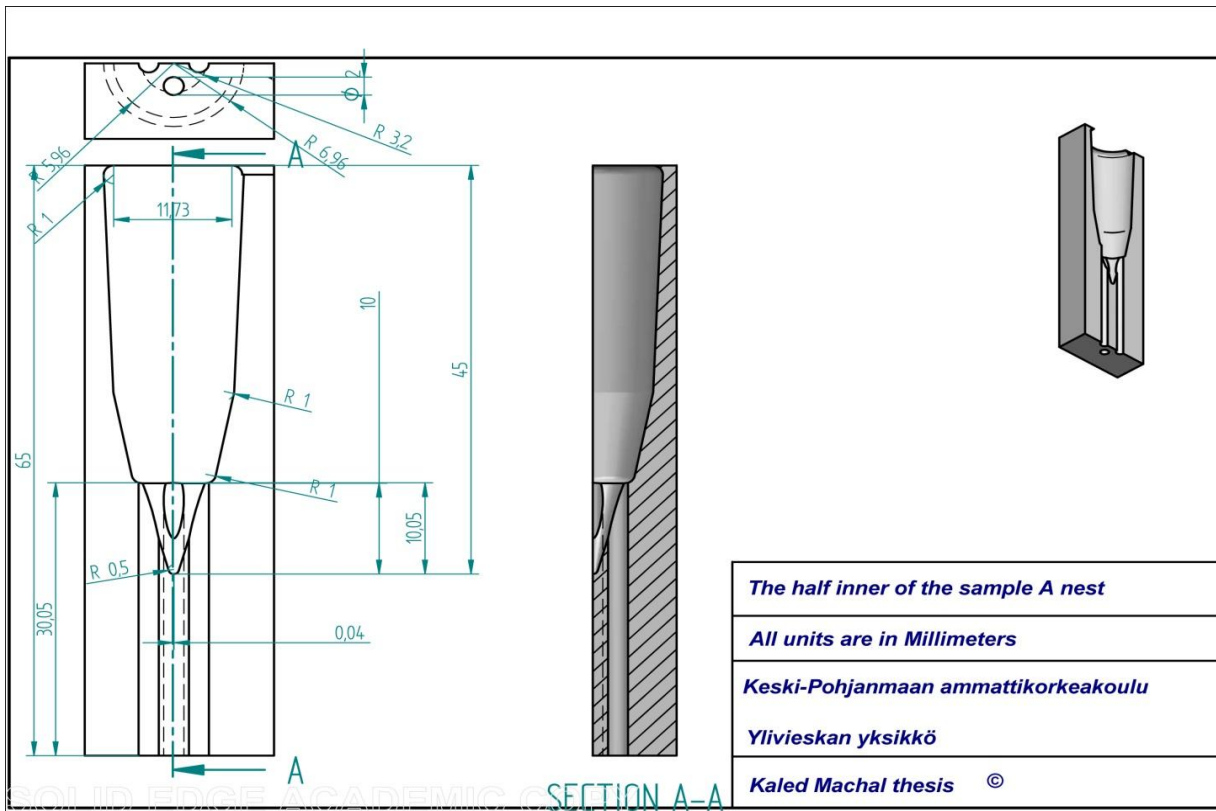

FIGURE 20. The drawing of the half cut out of the inner nest or cavity of the sample A

## 11.2 Draft core plate design sample A

The figure 21 shows the draft design for the core plate concerning the sample A.

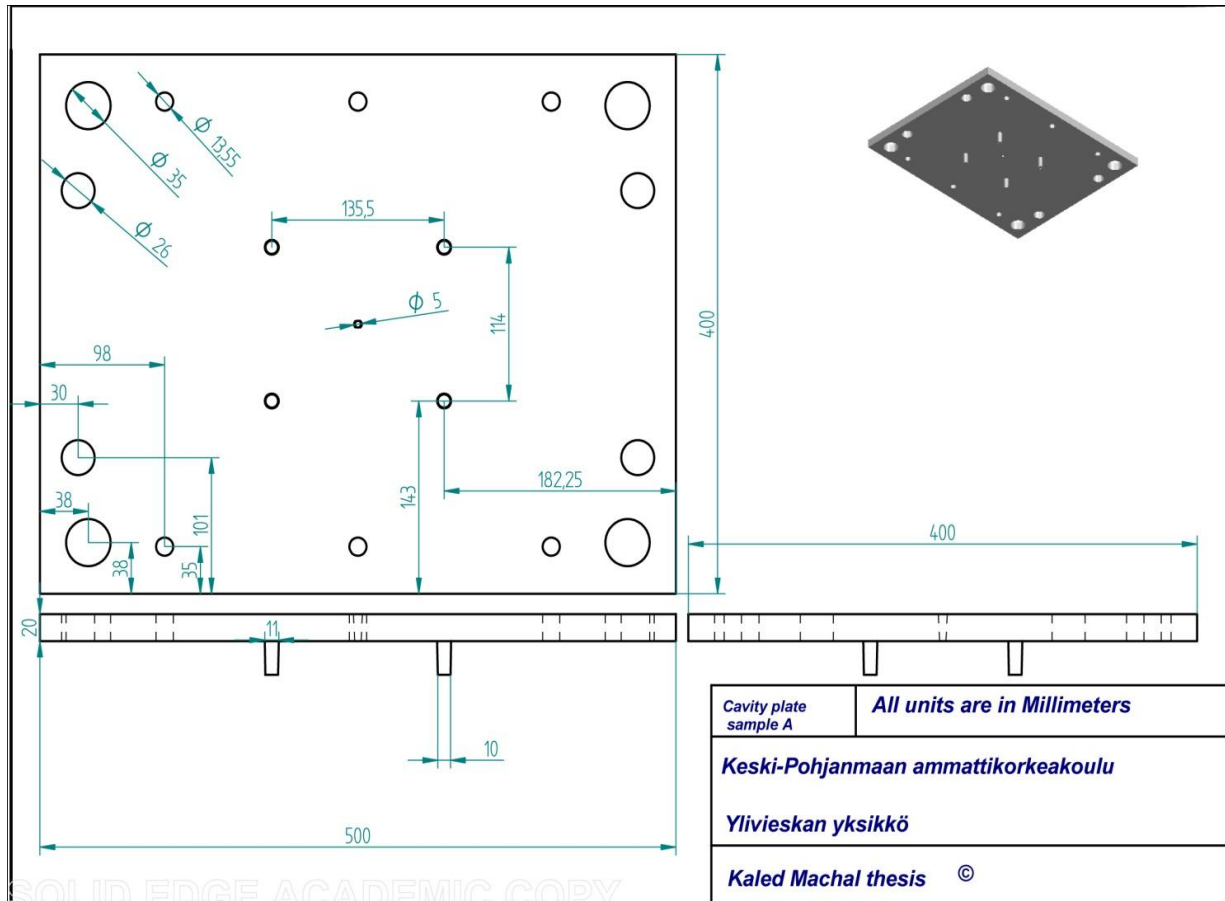

FIGURE 21. The draft design for the core plate concerning the sample A

### 11.3 Draft cavity plate design sample B

The figure 22 shows the cavity plate concerning the sample B. It looks similar to the cavity plate sample A. The only thing which distinguishes the cavity sample B from the cavity sample A is the size or the dimensions of the nest product. The figure 23 shows the design draft of cut out of the half inner nest concerning sample B. It will help to show the small hidden details.

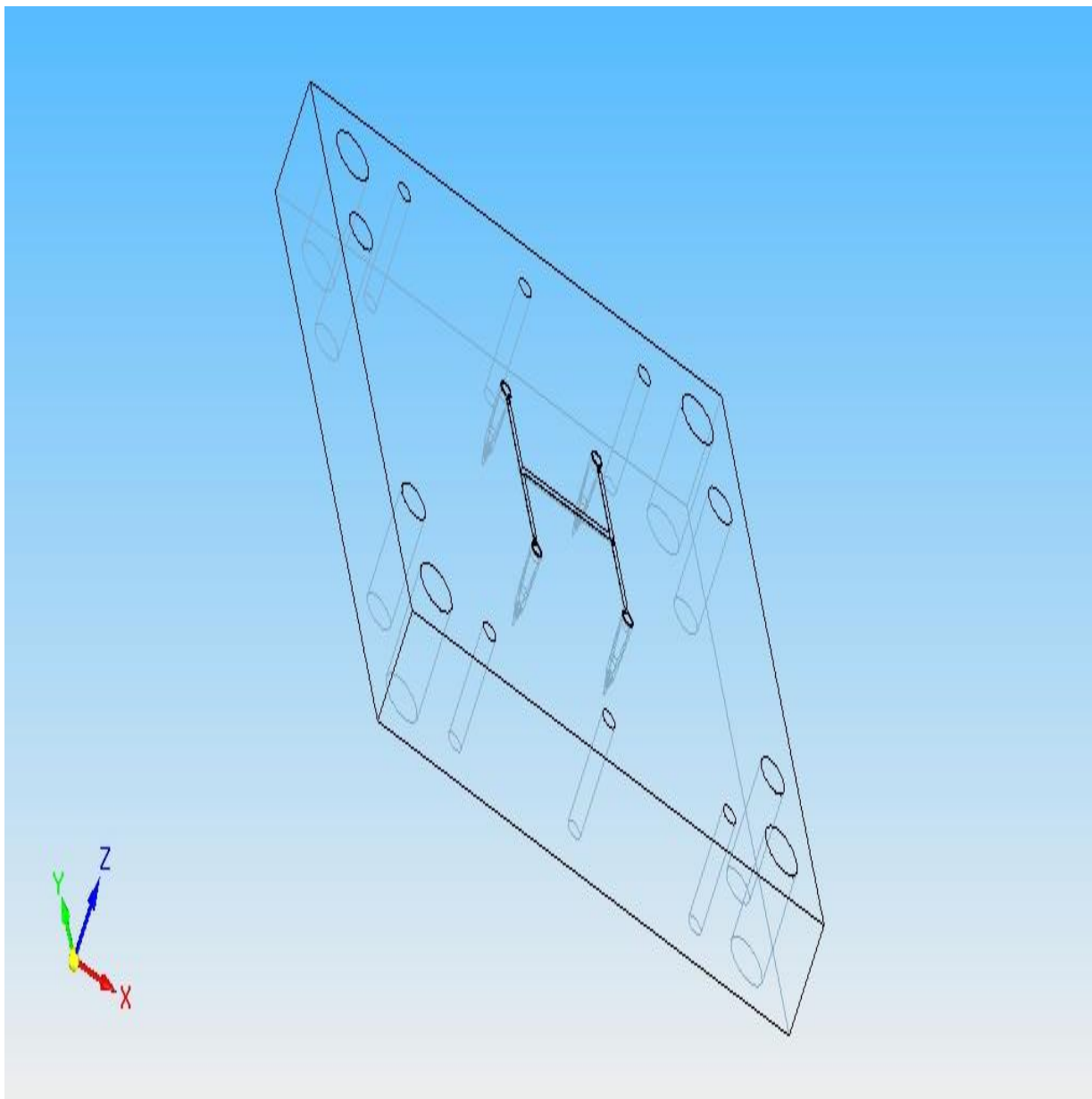

FIGURE 22. The cavity plate concerning the sample B

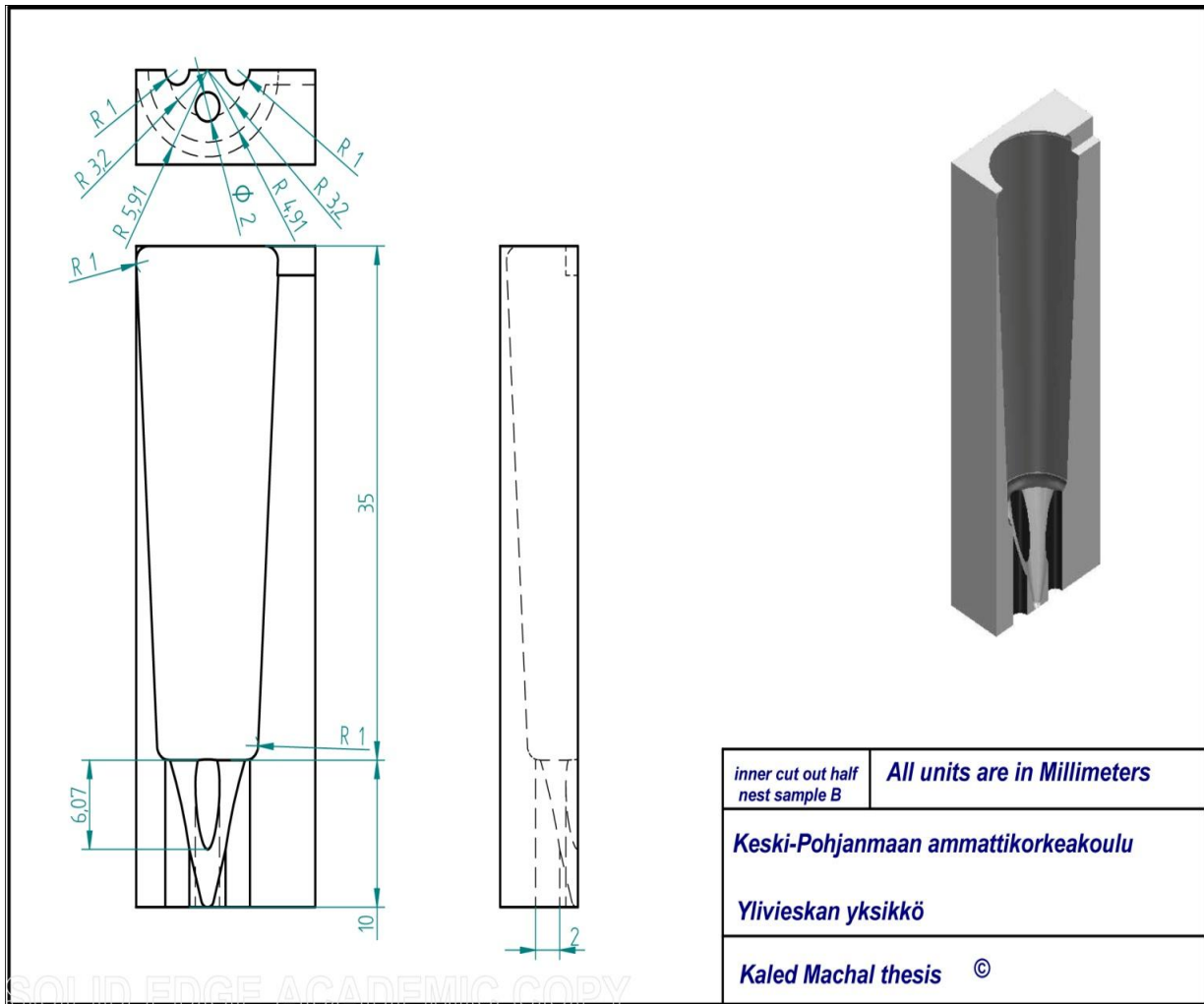

FIGURE23. The design draft of cut out of the half inner nest concerning sample B

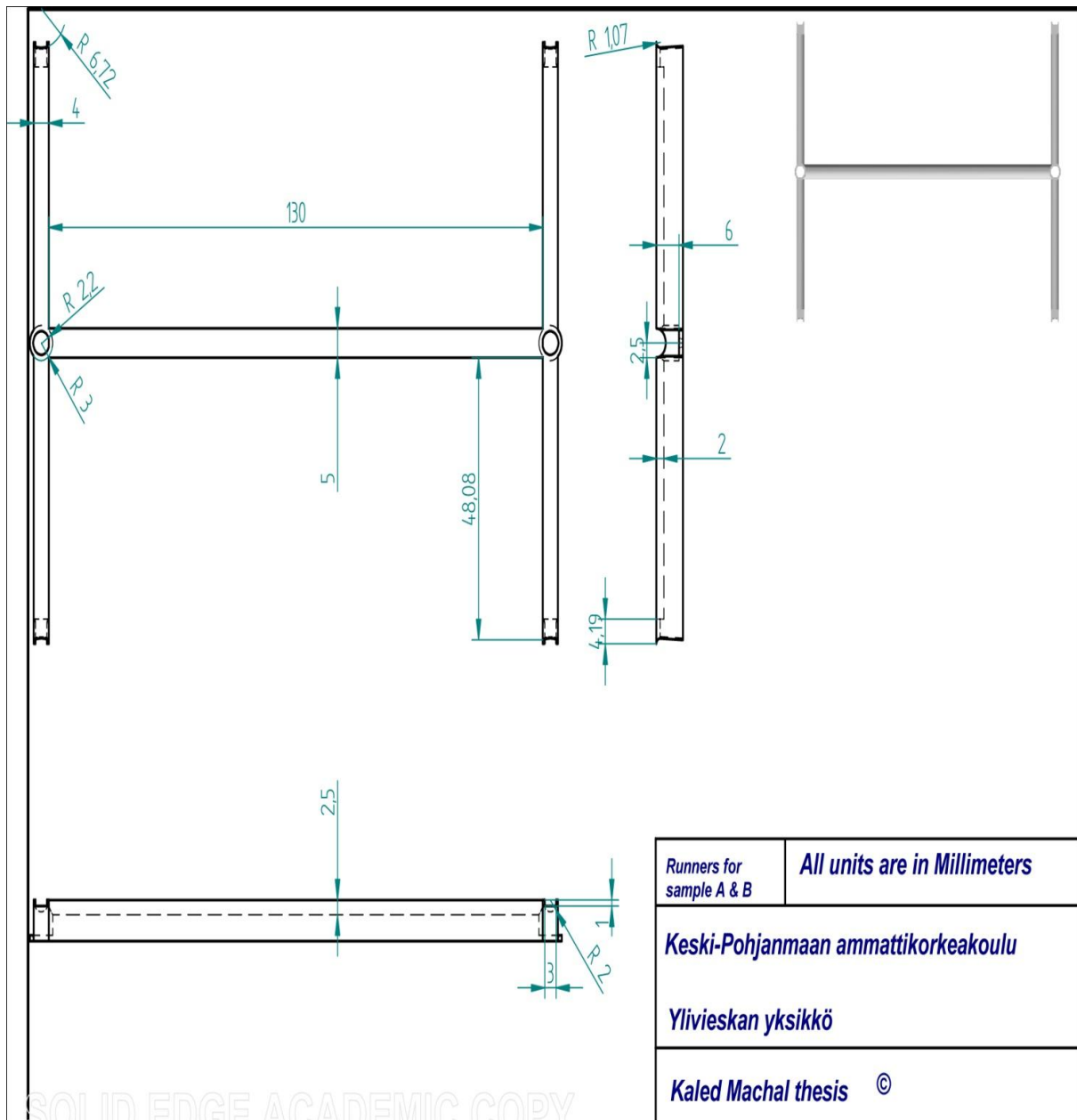

FIGURE 24. The draft design of runners for both sample and sample B

#### 11.4 Core plate design draft for sample B

The Figure 25 show how the core plate sample B looks like. The green features in the Figure 25 show the cores which enable the shape of the inner sample B. The figure 26 shows the draft design of the core plate concerning the sample B.

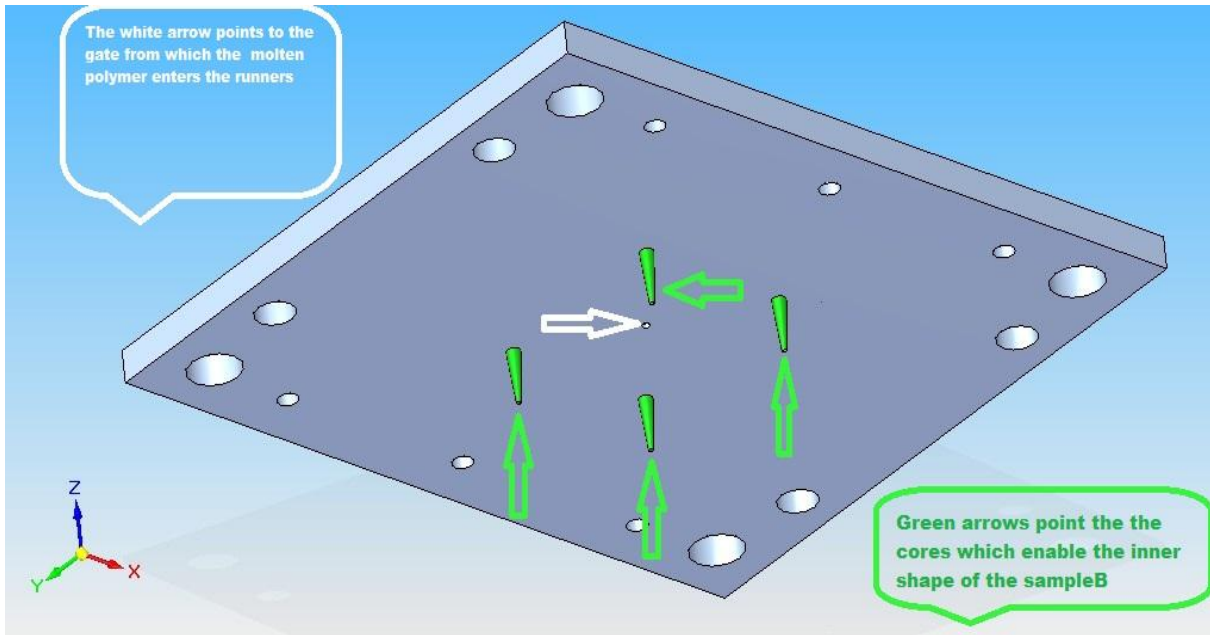

FIGURE 25. The core plate sample B out look

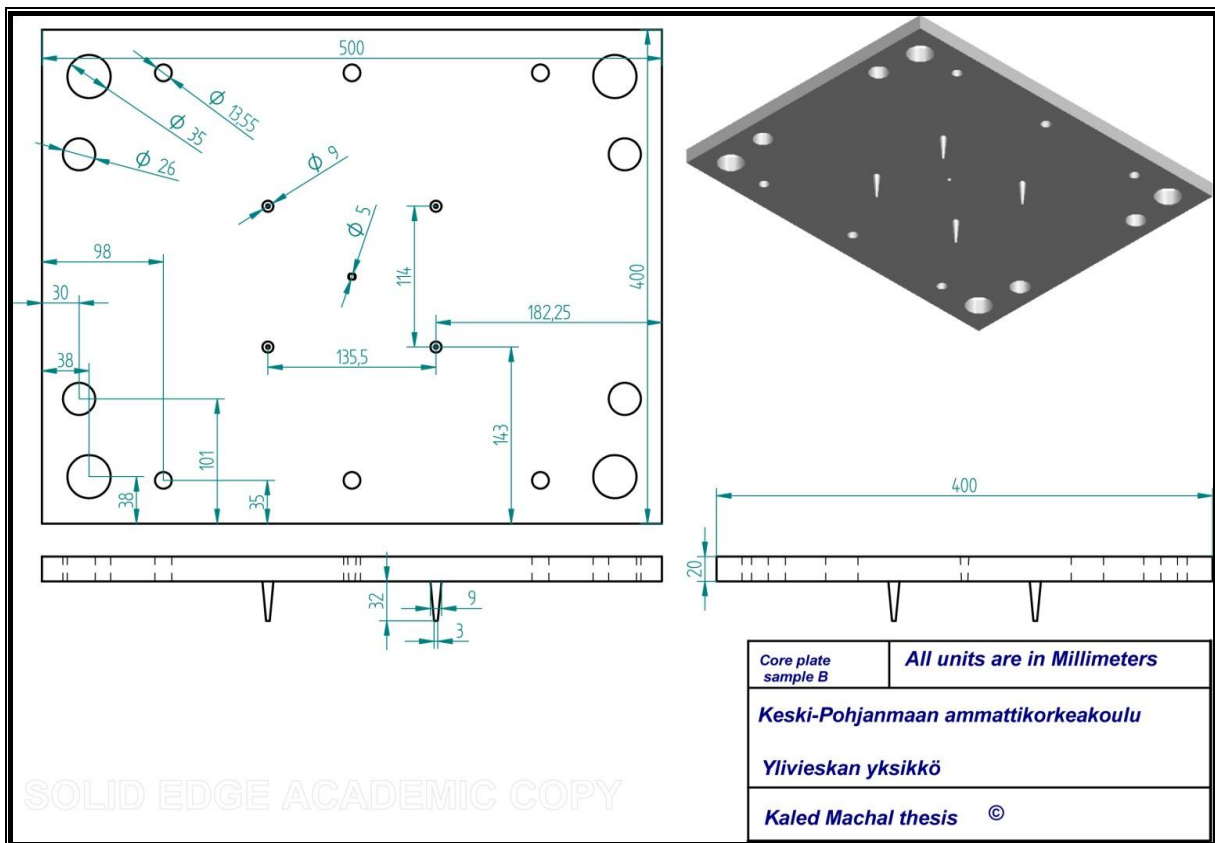

FIGURE 26. The draft design of the core plate concerning the sample B

### 11.5 G-codes & M-codes example (core plate sample A)

The G-codes and M-codes are in form of document in a large file, which is found in the attachment 1. The N Lines represent a specific task carried with the CNC



machine. It contains the coordinates of the cutting tool, the material removed, and the speed of the cutting tool. Some machines have a gear box which enables the use of fast cutting or drilling tools. The G and M codes are explained in table 2 and table 3.

## 11.6 Assembly

### 11.6.1 Assembly sample A

The cavity plate and the core plate are assembled to make sure they fit each other. The assembly regarding the sample A, (ore plate and cavity plate) is shown in the figure 27.

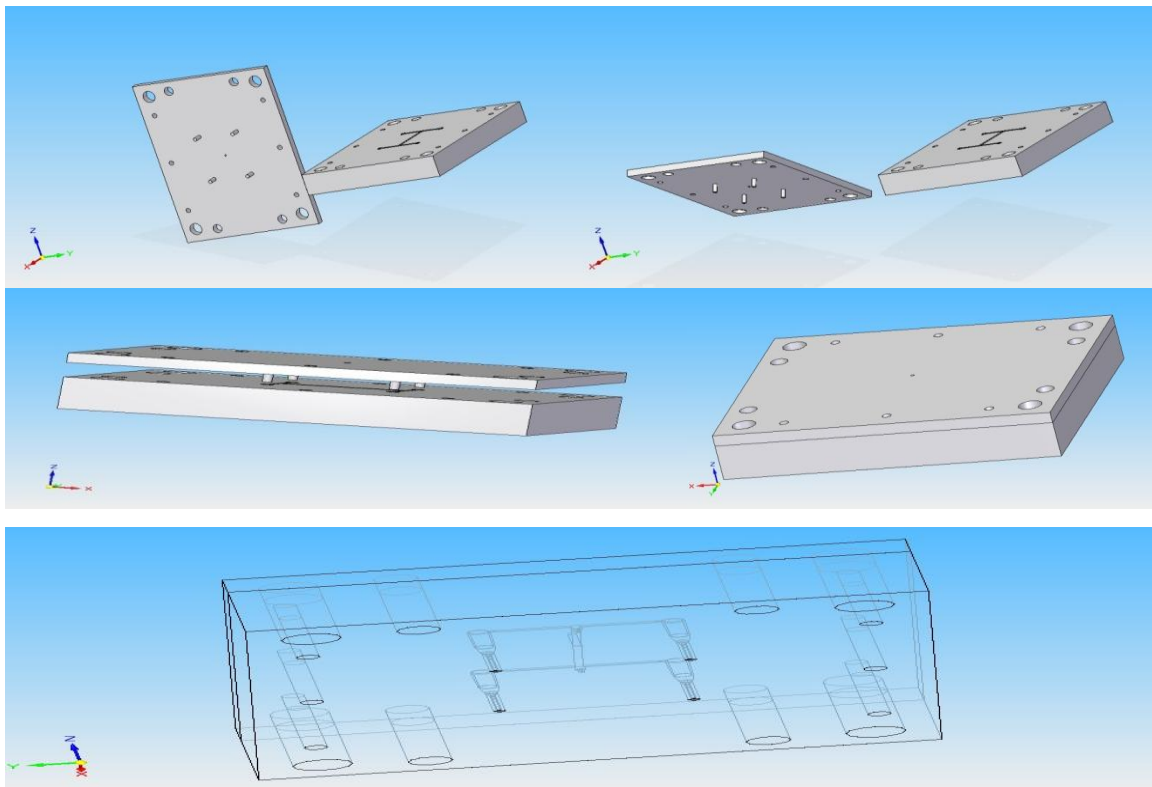

FIGURE 27. The assembly regarding the sample A, core plate and cavity plate

### 11.6.2 Assembly sample B

The cavity plate and the core plate are assembled to make sure they fit each other. The assembly regarding the sample B (core plate and cavity plate) is shown in the figure 28.

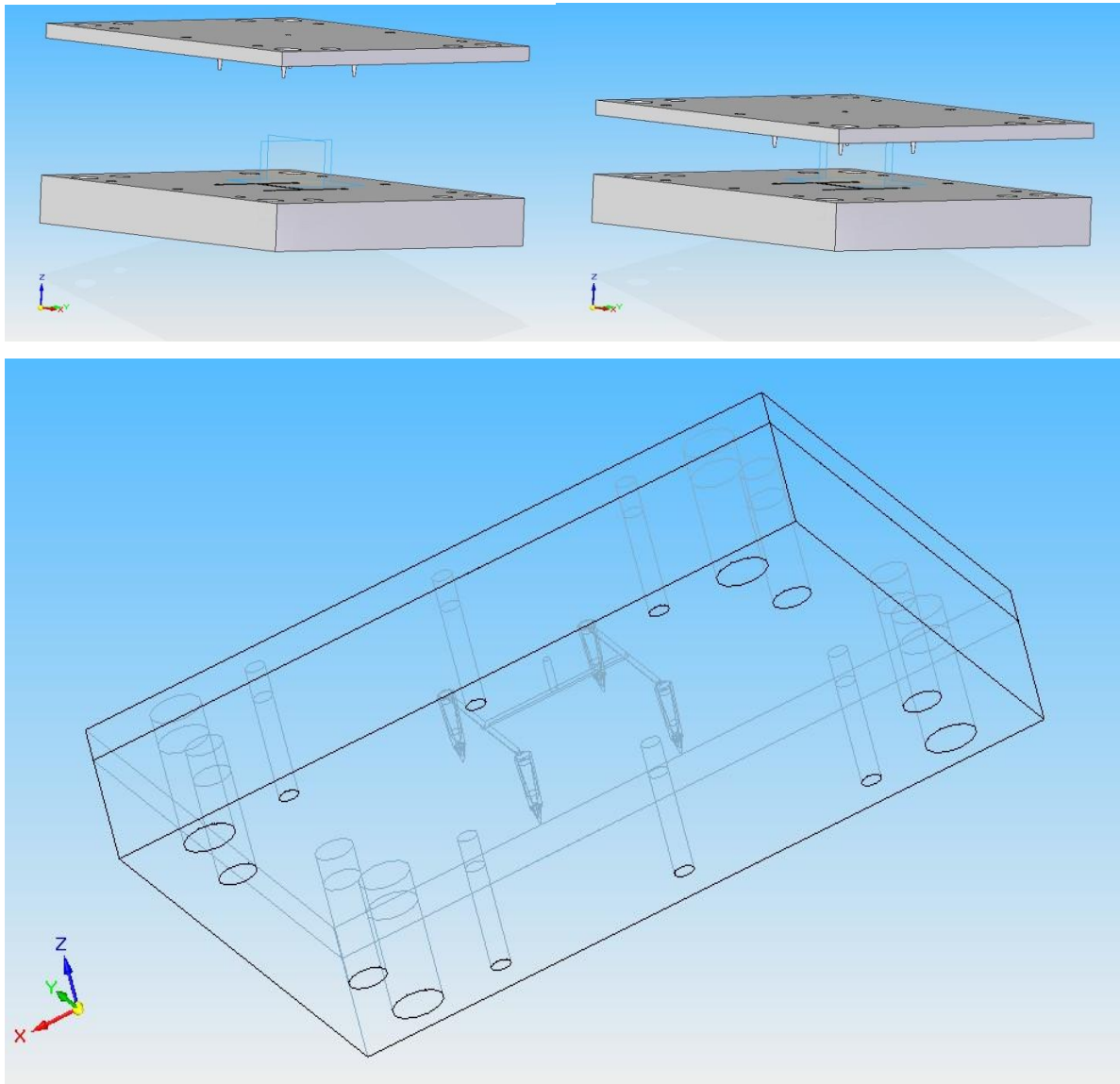

FIGURE 28. The assembly regarding the sample B, core plate and cavity plate

### 11.6.3 Mould View

The figure 29 shows the mold for the product sample A and sample B. The same mold will work for both samples. The mold was designed using mold tooling solid edge software. For each sample the mold cavity plate and core plate has to be changed according to the sample which is produced. The figure 30 shows the mold explodetion, which provides a closer look at the whole mould components.

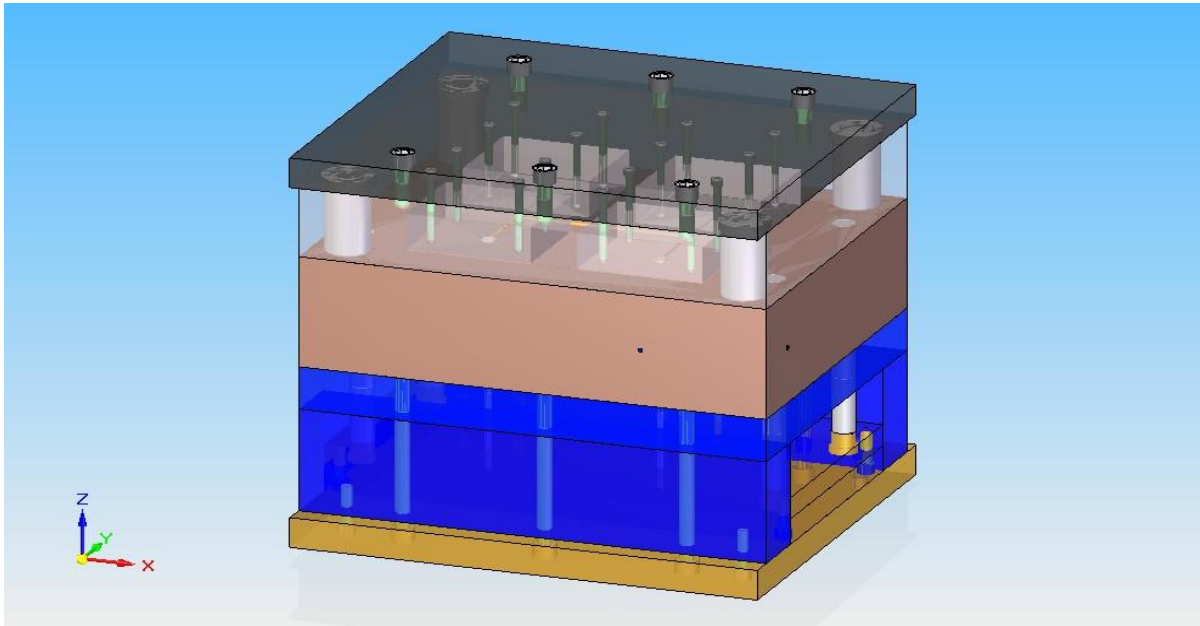

FIGURE 29. The mould for the product sample A and sample B

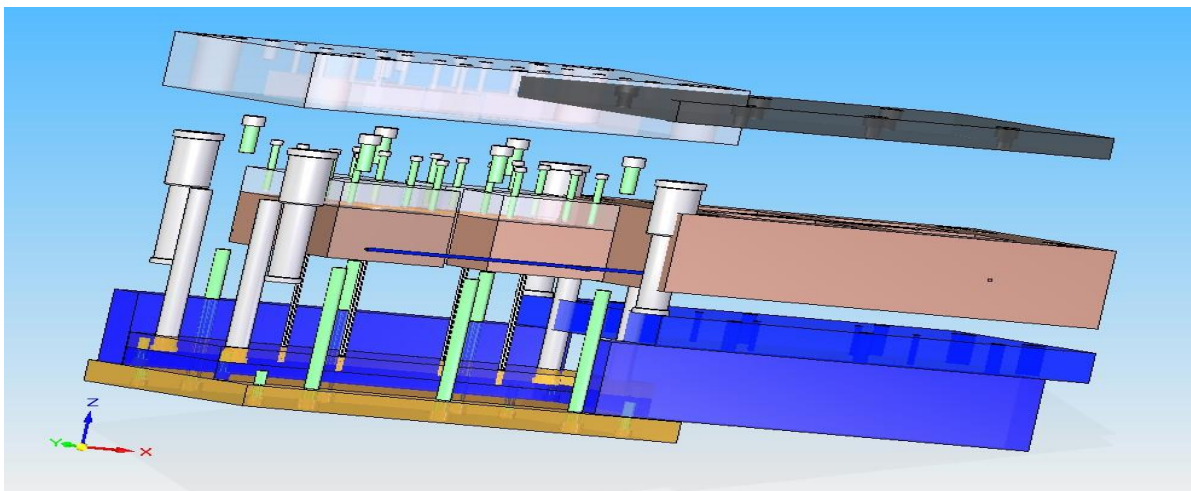

FIGURE 30. The mould explodetion

### 11.7 Clamping force

The clamping force is calculated as:

$$\text{Force} = \text{Area} \times \text{Pressure}$$

Area = projected area of the runners + projected area of the cavities. Solid edge software is used to calculate automatically the total projected area, which is about: 2000 mm<sup>2</sup>. Figure 31.

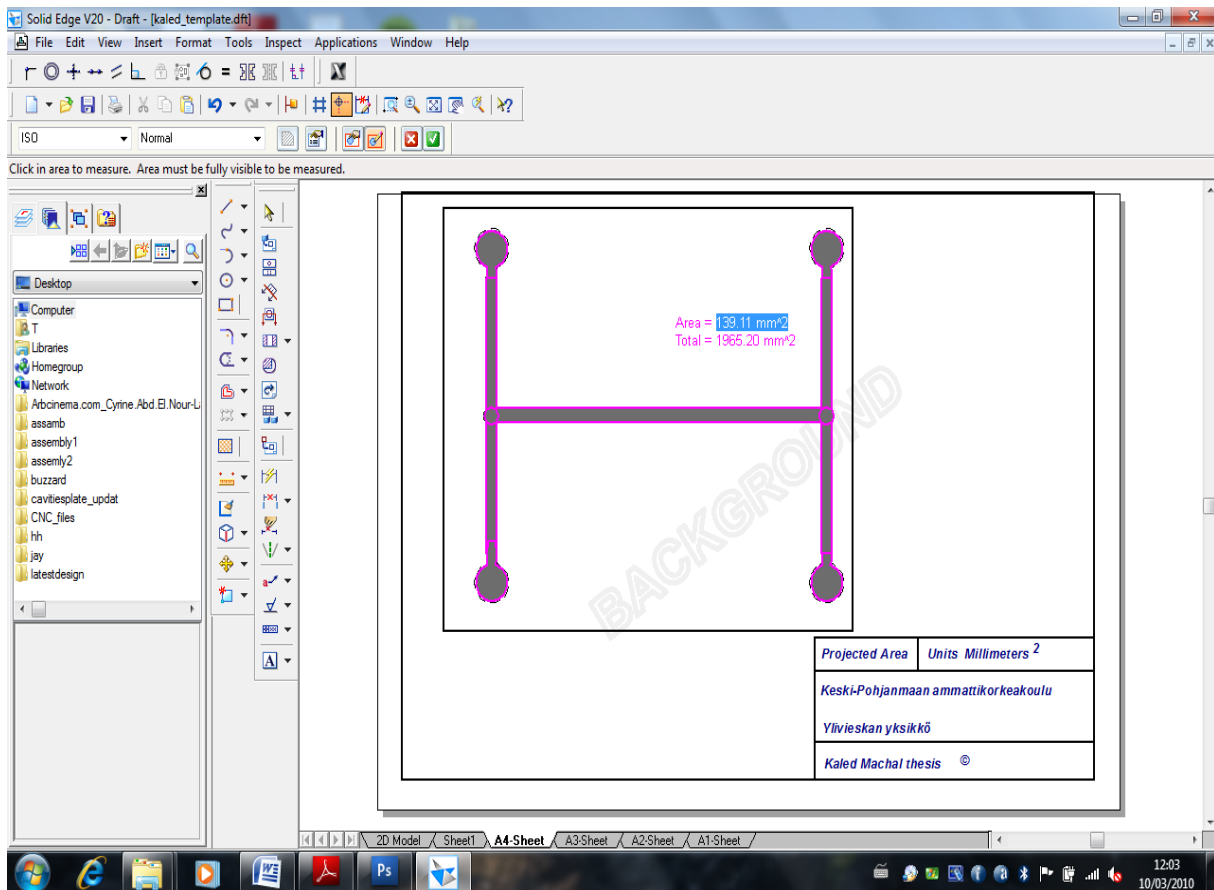
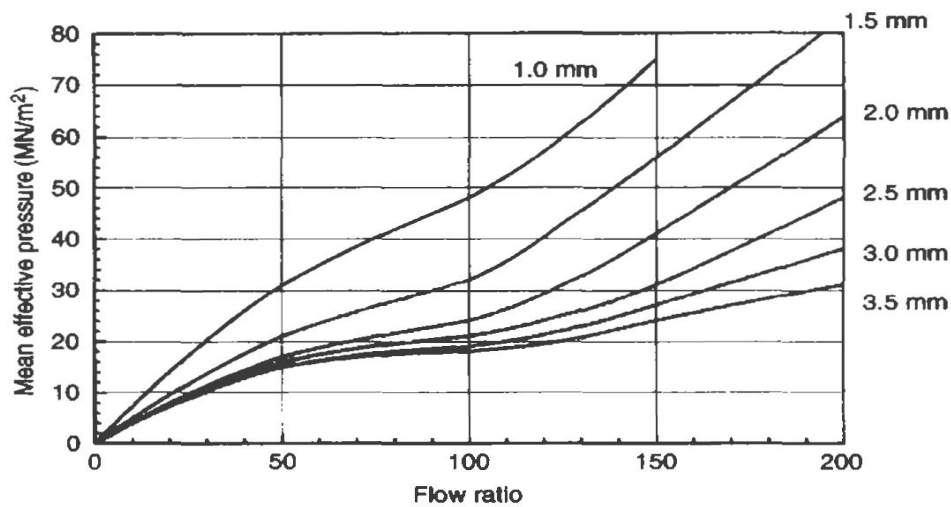

FIGURE 31. The total projected area

The greatest area is the area of the product sample A; therefore that area will be used to calculate the required clamping force. Knowing the clamping force will help to choose the suitable injection mold machine to produce the sample A and sample B. The pressure calculated according to the mean effective pressure which is related to the thickness of the product, the flow length. The flow length is the distance from where the molten polymer enters the runners until the bottom of the cavity sample A. The total length of the cavity from the top to the bottom is 25 mm, diameter 14 mm, small runner length is about 48 mm and the big runner is 65 mm, the total is:  $25+14+48+65 = 128$  mm. From the figure 32, flow ratio as  $128/2 = 64$  mm, looking to the thickness of 2 mm we get the mean effective pressure equal to  $20 \text{ MN/m}^2$ , (figure 32).



Clamping pressures for different cavity geometries (typical values for easy flow materials)

FIGURE 32. Clamping pressures for different cavity geometries (Crawford, 295.)

However the pressure used to calculate the clamping force is equal to the mean effective pressure time the viscosity factor time 1.15 (Allowing an extra 15% for uncertainties). The table 6 below shows the viscosity factor for some most used plastics.

Material	Viscosity Factor
Polyethylene, polypropylene, polystyrene	1
Nylon 66	1.2 → 1.4
ABS	1.3 → 1.4
Acrylic	1.5 → 1.7
PVC	1.6 → 1.8
Polycarbonate	1.7 → 2.0

TABLE 6. The viscosity factor for some polymers (Crawford, 295.)

It will be superior to select high viscosity factor, as 2.0 of polycarbonate. Recalling all the variables, the pressure required is:  $20 \times 2 \times 1.5 = 60 \text{ MN/m}^2$ . As a result, the clamping force is:  $60 \text{ MN/m}^2 \times 2000 \text{ m}^2 \times 10^{-6} = 120000 \text{ N} = 120 \text{ kN} = 12 \text{ tones}$  this will require only a normal injection molding machine to produce the product, and the capacity of the machine will be 12 tones.

## 11.8 PHYSICAL PROPERTIES OF THE SAMPLE A

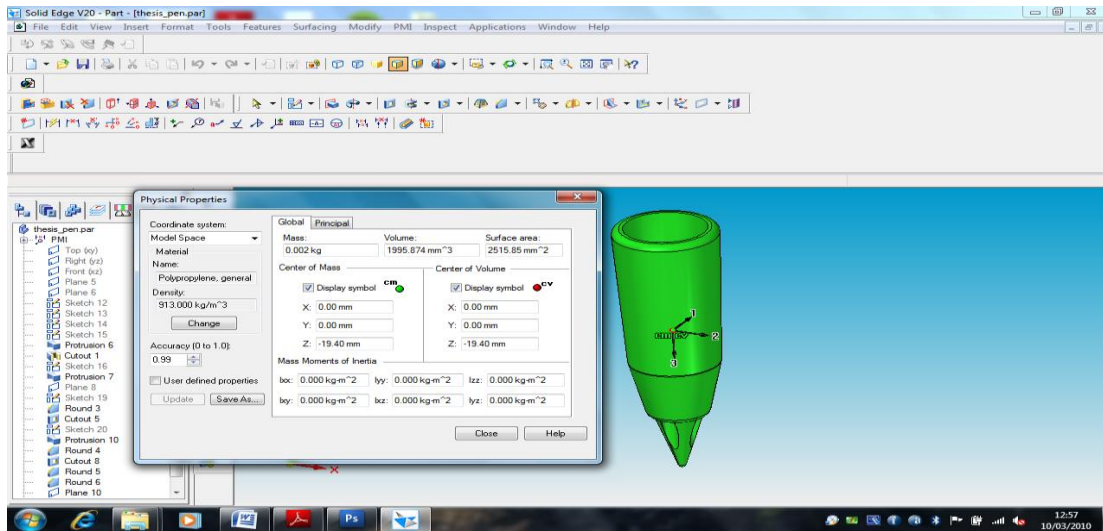

FIGURE 33. Polypropylene sample A mass. (0.002 Kg)

From the figure 33, it shows that the part mass is 0.002 Kg. The part material is polypropylene material used for a general purpose. The mass has been calculated automatically with the help of the designing program Solid Edge.

## 11.9 COST OF RECYCLED PLASTICS

Recycled plastics have different prices according to their family types; below there are prices for the most used recycled plastics

### RECYCLED RESIN PRICES

	Pellets	Flake
	cents/lb	cents/lb

#### PET Bottles (Clean)

Clear Post-Consumer	48-54	38-42
Green Post-Consumer	39-43	28-33

#### HDPE (Clean)

Natural Post-Consumer	33-36	21-22
Mixed Colors	27-30	18-21

## Polystyrene

## Post-Consumer

## High Impact

Black	36-38	32-34
Natural	40-42	-

## General Purpose

Black	30-32	16-18
Natural	34-36	28-30

## Polypropylene

Post-Industrial	21-27	17-18
-----------------	-------	-------

Post-Consumer	12-14	-
---------------	-------	---

## Polyethylene Film

## Post-Consumer

Stretch	28	-
Printed/Mixed	13	-

## Post-Industrial

Printed	20	-
Not Printed	24	-

## PVC

## Post-Industrial

Flexible	32-40	-
Rigid	50-68	-

(<http://www.thefreelibrary.com/Recycled+resin+prices+may+turn+softer.+%28Recycle+Pricing%29.-a0105644555>)

1lb = 0.453592 Kg

As an example the polypropylene recycled price per 1 Kg is  $27 \times 2 \text{ \$(USA)} = 0.54 \text{ \$/Kg}$ . The cost of one sample A is  $0.54 \times 0.002\text{Kg} = 0.00108 \text{ \$/Kg}$ . As estimation the price of one sample A is between 21 and 27 cents \$. (These because of the scrape resulting from the runners, but the scrape can be recycled and used again, with the

help of the granulator machine). The energy cost, work cost, the machine cost and the transport will be included. The real price as an estimate per one item is about 0.01 \$. According to the prices of the pen touch screen in Gigantti, Tarjoustalo, and Verkkokauppa which vary from 1 € to 10 €, it is worth selling 4 pieces in one packet with one Euro or two Euros.



## 12. PRODUCT EVALUATION

### 12.1 SWOT ANALYSIS

<b>Strength:</b>	<b>Weaknesses:</b>
Using recycled plastics Nature friendly (bio-degradable) Cheap production Offering new unique multicolor design	Unknown product Production method (how and where to produce the new invention) How to sell the product?
<b>Opportunities:</b>	<b>Threats:</b>
Enormous touch screen devices Many consumers Consumers nowadays are thinking about moral issues	Similar products are already in Market

TABLE 7. SWOT Analysis (Strength, weakness, Opportunity, Threat)

### 12.2 MARKETING

Using the table 7, representing SWOT analysis, the new product has a good position in the consumers market. The product can be offered to some company that sells pens or some company that sell touch screen devices. The product is so small that it can be use as standalone to navigate on touch screen devices or it can be plugged

in the most common pens and pencil. The product will be found in different types of colors. One packet will have 4 samples, two items from each sample A and sample B. The product will give a good image about the company in terms of using recycled material or biodegradable material.

### **12.3 RECOMMENDATION**

It will be a great idea to develop the new product for multi tasks, such as hair holders or pen cap. The product can be manipulated in order to bring new invention which will solve specific problems in our daily life. All material engineers have to develop new raw materials environmental friendly from non food resources.

### 13. REFERENCES

Anderson & Atkins: Anderson and Atkins Injection molding cycle, The College of Engineering at San Diego State University, by Helen Anderson and Jason Atkins  
<http://kahuna.sdsu.edu/~johnston/Injection%20Molding.pdf>

Read: 2.3.2010

ANILAM: G-codes for the CNC machine: ANILAM 5000M CNC Programming and Operations Manual 21-January-06, 43

ANILAM: M-codes for the CNC machine: ANILAM 5000M CNC Programming and Operations Manual 21-January-06, 226

Arcada UAS lab work December 2010

Colton : Manufacturing Processes and Engineering Prof. J.S. Colton Georia institute of technology : <http://www.me.gatech.edu/jonathan.colton/>

Read: 6.3.2010

Code numbers related to the most know plastics: [www.plasticfreebottles.com](http://www.plasticfreebottles.com)

Read: 2.3.2010

Crawford: Calculating the clamping force: Plastics engineering third edition, R J Crawford, 295

Elo Touch Systems, 2010

<http://inventors.about.com/library/inventors/bltouch.htm>

Read: 8.1.2010

European Plastics Recyclers

[http://www.plasticsrecyclers.eu/uploads/media/eupr/HowIncreaseRecycling/1265184667EUPR\\_How\\_To\\_Increase\\_Plastics\\_Recycling\\_FINAL\\_low.pdf](http://www.plasticsrecyclers.eu/uploads/media/eupr/HowIncreaseRecycling/1265184667EUPR_How_To_Increase_Plastics_Recycling_FINAL_low.pdf)

Read: 9.2.2010

Finnish company selling recycled plastic raw material:

<http://www.muoviportti.fi/english/index.htm>

Read: 12. 3. 2010

Happer: Modern Plastics Handbook, Charle. A Happer, 7-12

Injection molding history: <http://www.southwestplastics.com/learn-more/a-brief-history-of-plastic-injection-molding-process>

Read: 2.3.2010

Italian bio-plastic manufacturer Novamont , energy required to produce bioplastics raw material: <http://www.cosmeticsdesign.com/Packaging-Design/Bioplastics-will-become-more-price-competitive-say-manufacturers>

Read: 12.3.2010

Kutz: Handbook of Materials Selection, Myer Kutz 2001, 346-352

Mazda, 2010

<http://green.autoblog.com/2009/03/23/mazda-develops-automatic-bumper-recycling-process/>

Read: 8.1.2010

Market research: gigantti, verkkokauppa,tarjoistalo, 2010

McCarthy: McCarthy, Biodegradable Polymers, 22-27

Modern Plastics Handbook, Charle. A Happer, 79-83

Nancy Paxton : Nany Paxton the Apple Investor Relations department  
(Information sent by e-mail)

Nokia, 2010

<http://www.nokia.fi/asiakastuki-ja-ohjelmistot/tuotetuki/nokia-7710>

Read: 22.2.2010

National Board of Patents and Registration of Finland (NBPR)

<http://www.prh.fi/en/patentit/hakusuomi/millaiseen.html>

Read: 10.3.2010

Rosato : Injection Molding Handbook (3rd Edition) by Rosato, D.V.; Rosato, D.V.; Rosato, M.G. © 2000, p 4

Samsung, 2010

[http://www.samsung.com/us/consumer/mobile/mobile-phones/verizon-wireless-phones/SCH-I920DAAVZW/index.idx?pagetype=prd\\_detail&returnurl=](http://www.samsung.com/us/consumer/mobile/mobile-phones/verizon-wireless-phones/SCH-I920DAAVZW/index.idx?pagetype=prd_detail&returnurl=)

Read: 22.2.2010

Solid edge software customers and it uses in the designing industrial field:  
[http://www.plm.automation.siemens.com/en\\_us/products/velocity/solidedge/overview](http://www.plm.automation.siemens.com/en_us/products/velocity/solidedge/overview)

[/index.shtml](#)

Read: 2.2.2010

Summer work Bowtec OY 2008

Summer work 2009 in rinotop OY

The CNC machine screen monitor, Machine Control Unit (MCU):

[http://www.fidia.it/download/brochure/classe\\_c\\_it.pdf](http://www.fidia.it/download/brochure/classe_c_it.pdf)

Read: 14.3.2010

Southwest plastics , plastics manufacturer: <http://www.southwestplastics.com/learn-more/a-brief-history-of-plastic-injection-molding-process>

Read: 2.3.2010

The compelling facts about plastics 2008: Recycling and energy rates per country.

The compelling facts about plastics 2009

[http://www.plasticsrecyclers.eu/uploads/media/eupr/HowIncreaseRecycling/1265184667EUPR\\_How\\_To\\_Increase\\_Plastics\\_Recycling\\_FINAL\\_low.pdf](http://www.plasticsrecyclers.eu/uploads/media/eupr/HowIncreaseRecycling/1265184667EUPR_How_To_Increase_Plastics_Recycling_FINAL_low.pdf)

Read: 10.2.2010

The price of the most recycled plastics:

<http://www.thefreelibrary.com/Recycled+resin+prices+may+turn+softer.+%28Recycle+Pricing%29.-a0105644555>

Read: 10.4.2010

Waters: Fundamentals of MANUFACTURING FOR ENGINEERS, Fred waters, 242, 249, 255

## Attachment 1: The G-codes and M-codes

%

O0000

(PROGRAM NAME - Core plate sample A)

(DATE=DD-MM-YY - 12-03-10 TIME=HH:MM - 22:13 )

N100 G21

N102 G0 G17 G40 G49 G80 G90

( 20. FLAT ENDMILL TOOL - 229 DIA. OFF. - 229 LEN. - 229 DIA. - 80. )

N104 T229 M6

N106 G0 G90 G54 X407.481 Y-81.819 A0. S800 M3

N108 G43 H229 Z30.145

N110 G1 Z27.145 F800.

N112 X408.272 Y-82.996 Z27.101

NB: The real code file contains 1036 pages, usually this file (G-codes and M-codes) is saved as data in memory card or USB memory then plugged in the CNC machine which will follow the orders content of the data file.

